

K-MET

K-MET

Measuring Tools



K-MET 2025

VÝROBA MĚŘICÍCH NÁSTROJŮ MANUFACTURE OF MEASURING TOOLS PRODUKCJA PRZYRZĄDÓW POMIAROWYCH

**TRADICE OD ROKU 1893
TRADITION SINCE 1893
TRADYCJA OD 1893**

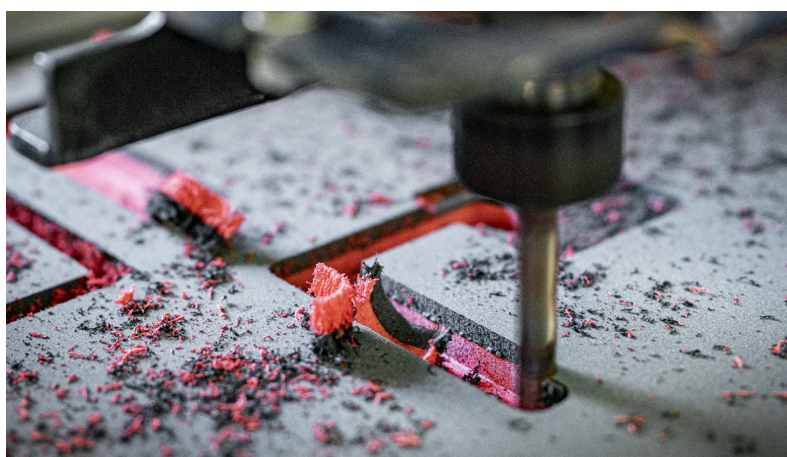
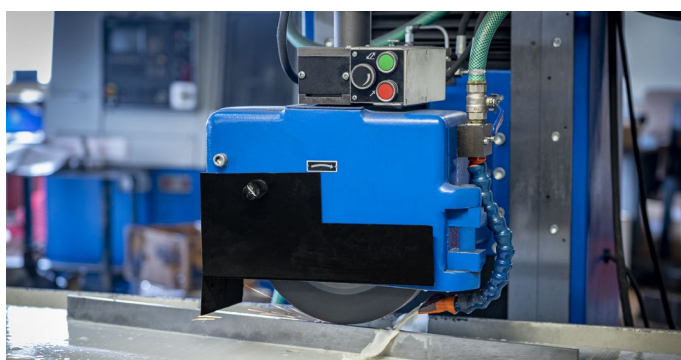

Piktogramy | Pictograms | Piktogramy

	<p>Stupeň krytí Ingress Protection Marking Stopień ochrony</p>		<p>Rozměry šířka x výška x hloubka Dimensions Width x Height x Depth Wymiary szerokość x wysokość x głębokość</p>
	<p>Vyrobeno dle české technické normy Manufactured according to Czech standards Wyprodukowane zgodnie z czeskimi normami technicznymi</p>		<p>Rozsah měření Measuring range Zakres pomiarowy</p>
	<p>Vyrobeno dle německé národní normy Manufactured according to German national standards Wyprodukowane zgodnie z niemieckimi normami technicznymi</p>		<p>Rozlišení Resolution Rozdzielczość</p>
	<p>Vyrobeno dle podnikové normy K-MET Manufactured according to company standards K-MET Wyprodukowane zgodnie ze standardami firmy K-MET</p>		<p>Přesnost Accuracy Dokładność</p>
	<p>Vyrobeno z nerezové oceli Made of stainless steel Wyprodukowane ze stali nierdzewnej</p>		<p>Průřez Cross-section Przekrój</p>
	<p>Vyrobeno ze slitiny hliníku Made of aluminum alloy Wyprodukowane ze stopu aluminium</p>		<p>Nestandardní přeprava Non-standard transportation Niestandardowy transport</p>
	<p>Třída přesnosti Class of accuracy Klasa dokładności</p>		<p>Magnetické upínání Magnetic Uchwyt magnetyczny</p>
	<p>Rozlišení 0,01 Resolution 0.01 Rozdzielczość 0,01</p>		<p>Nová řada měřidel News Nowy typ urządzeń pomiarowych</p>
	<p>Rozlišení 0,001 Resolution 0,001 Rozdzielczość 0,001</p>		<p>Novinka News Aktualności</p>
	<p>Rychloposuv 2 mm / ot. Quick displacement 2 mm / rev Szybko odkręcana 2 mm / obr.</p>		<p>Bezdrátový přenos dat - Bluetooth Wireless data transfer - Bluetooth Bezprzewodowy transfer danych - Bluetooth</p>
	<p>Sada obsahuje Set contains Zestaw zawiera</p>		

e-shop: <https://shop.k-met.com>

Aktuální katalog a ceník včetně kalibrací najdete na www.k-met.com.

Fotografie výrobků nemusí vždy odpovídat provedení výrobku z důvodu technické obměny sortimentu.

Rozměry výrobků jsou pouze orientační.

Tiskové chyby vyhrazeny.

The current catalog and price list including calibration can be found at www.k-met.com.

Product photos may be different from the real products due to technical upgrading of range.

Product dimensions are indicative only.

Printing errors stipulated.

Aktualny katalog oraz ceny dostępne są na : www.k-met.com.

Z powodu różnych wykonań poszczególnych narzędzi, ich wygląd nie zawsze odpowiada zdjęciom na naszych stronach i w sklepie internetowym.

Wymiary produktu są jedynie orientacyjne.

Przepraszamy za błędy wynikłe w druku.

Obsah | Contents | Zawartość

Měřítka Rulers Przymiary	2 - 5	Hmatadla Internal & External Calipers Macki	26
Pravítka Straight edges Liniały	6 - 7	Rýsovací jehly a tužky Scribers Rysik i ołówek	27
Příměrné desky a stoly Surface Plates, Tables Płyty traserskie i stoly	8 - 9	Vratidla & Nástavce závitníků Tap Wrenches & Tap Extensions Pokrętła & Przedł. do gwintowników	28
Rýsovací podložky V - blocks Przmy pomiarowe	10	Úhelníky Squares Kątowniki	29 - 37
Měrky Slip & Pin Gauge Sets Szczelinomierze	11 14 - 17	Vodováhy Spirit Levels Poziomice	38 - 41
Lupy Magnifying Glasses Lupy	12	Posuvná měřítka Calipers Suwmiarki	42 - 54
Tloušťkoměry Thickness Gauges Mierniki grubości	12, 59	Lesnické průměrky Forester Calipers Suwmiarki leśnicze	54
Úhломěry Protractors Kątomierze	13	Mikrometry Micrometers Mikrometry	55 - 66
Šablony Gages Szablony	15	Svinovací metry Measuring Tapes Miary zwijane	67 - 70
Stojánky Stands Podstawki	18 - 19	Pásma Long Tapes Miary zwijane	71 - 72
Úchylkoměry Indicators Czujniki	19 - 23	Sady Gauge Sets Zestawy	73 - 76
Výškoměry Height Gauges Wysokościomierze	23	Kalibry Gauges Sprawdziany	77 - 82
Hloubkoměry Depth Gauges Głębokościomierze	24 - 25	Ostatní Others Inne	83
Kružidla Spring Bow Dividers Cyrkle	25	Doplňkový sortiment Additional assortment Dodatkowy asortyment	84 - 85

K-MET a. s.

 1. mája 1200
014 01 Bytča
Slovakia

 tel.: +420 775 418 428
objednavky@k-met.com

K-MET a. s.

 1. mája 1200
014 01 Bytča
Slovakia

 tel.: +421 911 831 548
objednavky@k-met.com

K-MET a. s.

 1. mája 1200
014 01 Bytča
Slovakia

 tel.: +420 778 014 145
export@k-met.com

K-MET a. s.

 1. mája 1200
014 01 Bytča
Slovakia

 tel.: +48 784 764 696
polska@k-met.com

Měřítka | Rulers | Przymiary

Měřítko ocelové, ploché s přesahem, popis laserem
Steel Ruler with mm graduation, laser marking
Przymiar kreskowy sztywny, znakowanie laserowe

DIN
866/A

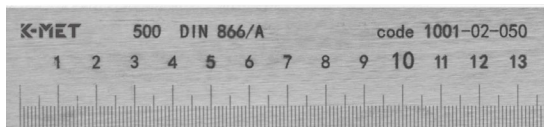

DALŠÍ ROZMĚRY NA ZAKÁZKU
OTHER SIZES ON REQUEST
INNE WYMIARY NA ZAMÓWIENIE

BEZ POVRCHOVÉ ÚPRAVY | WITHOUT FINISH | NIEPOWLEKANE

CODE	L [mm]	l [mm]	s [mm]	t [mm]
1001-02-030	310	300	25	5
1001-02-050	510	500	30	6
1001-02-100	1010	1000	40	8
1001-02-150	1510	1500	40	8
1001-02-200	2010	2000	50	10

NEREZOVÁ OCEL | STAINLESS STEEL | STAL NIERDZEWNA

INOX

CODE	L [mm]	l [mm]	s [mm]	t [mm]
1001-07-030	310	300	25	5
1001-07-050	510	500	30	6
1001-07-100	1010	1000	40	8
1001-07-150	1510	1500	40	8
1001-07-200	2010	2000	50	10

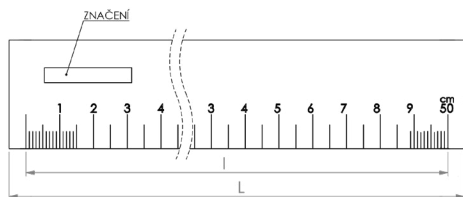

Měřítko ocelové, ploché s úkosem, popis laserem
Steel Bevelled Ruler with mm graduation, laser marking
Przymiar kreskowy sztywny ze skosem, opis laserowy

DIN
866/B

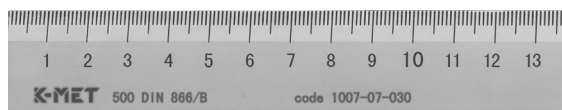

BEZ POVRCHOVÉ ÚPRAVY | WITHOUT FINISH | NIEPOWLEKANE

CODE	L [mm]	l [mm]	s [mm]	t [mm]
1007-02-030	310	300	25	5
1007-02-050	510	500	25	5
1007-02-100	1010	1000	30	6
1007-02-150	1510	1500	30	6
1007-02-200	2010	2000	40	8

NEREZOVÁ OCEL | STAINLESS STEEL | STAL NIERDZEWNA

INOX

CODE	L [mm]	l [mm]	s [mm]	t [mm]
1007-07-030	310	300	25	5
1007-07-050	510	500	25	5
1007-07-100	1010	1000	30	6
1007-07-150	1510	1500	30	6
1007-07-200	2010	2000	40	8

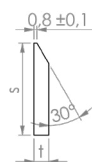
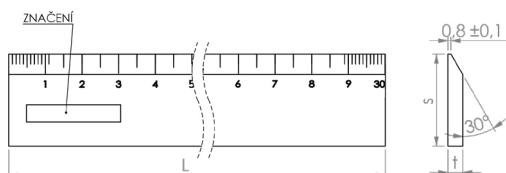

Měřítka | Rulers | Przymiary

Měřítko ocelové ploché, začátek v nule, popis laserem
Steel Ruler with mm graduation, laser marking
Przymiar kreskowy sztywny, opis laserowy

DIN
866/B



DALŠÍ ROZMĚRY NA ZAKÁZKU
OTHER SIZES ON REQUEST
INNE WYMIARY NA ZAMÓWIENIE

BEZ POVRCH. ÚPRAVY | WITHOUT FINISH | NIEPOWLEKANE

CODE	L [mm]	s [mm]	t [mm]
1012-02-030	300	25	5
1012-02-050	500	25	5
1012-02-100	1000	30	6
1012-02-150	1500	30	6
1012-02-200		40	8
1012-02-250		40	8
1012-02-300		40	8
1012-02-400		50	10
1012-02-500		60	12

NEREZOVÁ OCEL | STAINLESS STEEL | STAL NIERDZEWNA

INOX

CODE	L [mm]	s [mm]	t [mm]
1012-07-030	300	25	5
1012-07-050	500	25	5
1012-07-100	1000	30	6
1012-07-150	1500	30	6
1012-07-200		40	8

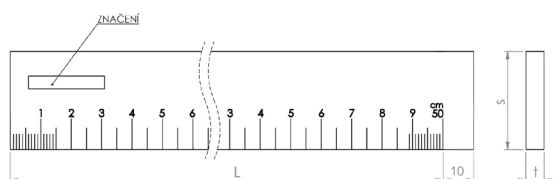

Nemagnetické | Non-magnetic | Niemagn. ULTRA-LIGHT

AI

CODE	L [mm]	s [mm]	t [mm]
1012-04-030	300	32	5
1012-04-050	500	32	5
1012-04-100	1000	32	5

Měřítko ocelové ploché, začátek v nule, stupnice INCH, popis laserem
Steel Ruler with INCH graduation, laser marking
Przymiar kreskowy sztywny, skala INCH, opis laserowy

Měřítko s vertikální stupnicí, popis laserem
Steel Ruler with vertical mm scale, laser marking
Przymiar kreskowy sztywny z pionową skalą, opis laserowy

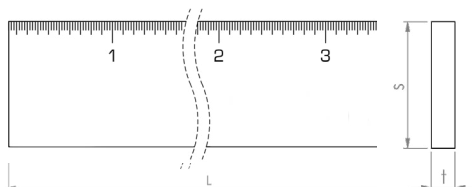

NEREZOVÁ OCEL | STAINLESS STEEL | STAL NIERDZEWNA

INOX

CODE	L	s [mm]	t [mm]
1012-07-024	24"	25	5
1012-07-040	40"	32	6

BEZ POVRCH. ÚPRAVY | WITHOUT FINISH | NIEPOWLEKANE

CODE	L [mm]	s [mm]	t [mm]
1027-02-050	500	25	5
1027-02-100	1000	32	6

NEREZOVÁ OCEL | STAINLESS STEEL | STAL NIERDZEWNA

INOX

CODE	L [mm]	s [mm]	t [mm]
1027-07-050	500	25	5
1027-07-100	1000	30	6

Měřítka | Rulers | Przymiary

Měřítko ocelové tenké BLACK COAT, laser: popis (vhodné pro kalibraci)
 Steel Thin Ruler BLACK COAT, laser marking (suitable for calibration)
 Przymiar kreskowy półsztywny BLACK COAT, opis laser: (nadaje się do kalibracji)

1 EC-DIN 2004/22 I class

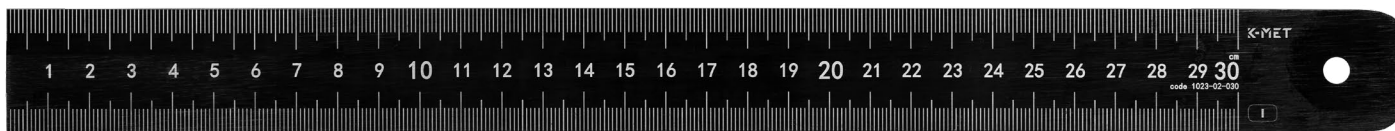

CODE	L [mm]	s [mm]	t [mm]
1023-02-015	150	30	1
1023-02-030	300	30	1
1023-02-030P	300	30	1
1023-02-050	500	30	1
1023-02-050P	500	30	1
1023-02-100	1000	30	1
1023-02-100P	1000	30	1

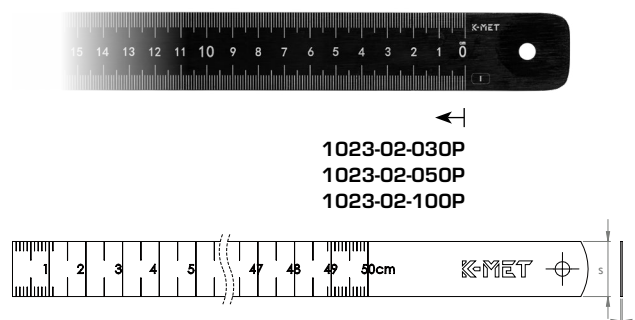

Měřítko ocelové tenké, laserový popis (vhodné pro kalibraci)
 Steel Thin Ruler, laser marking (suitable for calibration)
 Przymiar kreskowy półsztywny, opis laserowy (nadaje się do kalibracji)

1 EC-DIN 2004/22 I class

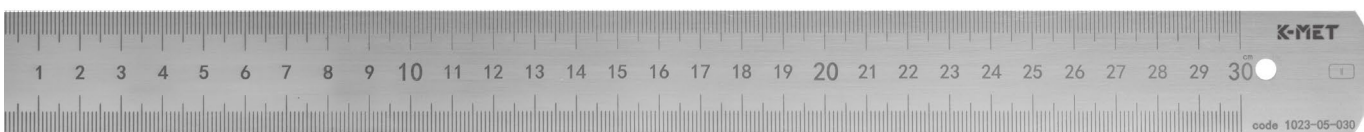

CODE	L [mm]	s [mm]	t [mm]
1023-05-015	150	30	1
1023-05-030	300	30	1
1023-05-030P	300	30	1
1023-05-050	500	30	1
1023-05-050P	500	30	1
1023-05-100	1000	30	1
1023-05-100P	1000	30	1
1023-05-150	1500	30	1
1023-05-200	2000	30	1

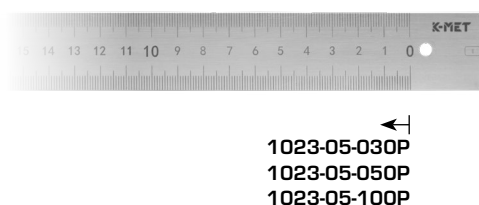

Měřítko ocelové tenké, laserový popis (vhodné pro kalibraci)
 Steel Thin Ruler, laser marking (suitable for calibration)
 Przymiar kreskowy półsztywny, opis laserowy (nadaje się do kalibracji)

0,5 EC-DIN 2004/22 I class

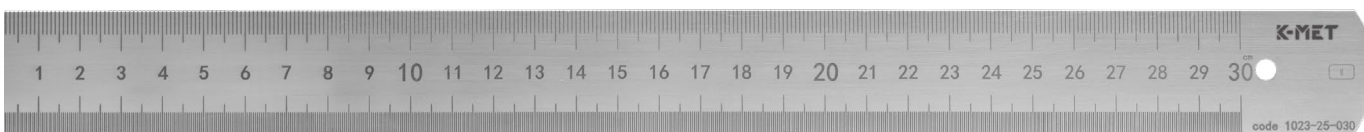

CODE	L [mm]	s [mm]	t [mm]
1023-25-015	150	30	1
1023-25-030	300	30	1
1023-25-050	500	30	1
1023-25-100	1000	30	1

Měřítka | Rulers | Przymiary

Měřítka ocelové tenké - barevné značení, převodní tabulka, laserový popis
Steel Thin Ruler - color marking, conversion table, laser marking
Przymiar kreskowy półsztywny, tabela przeliczeniowa, opis laserowy

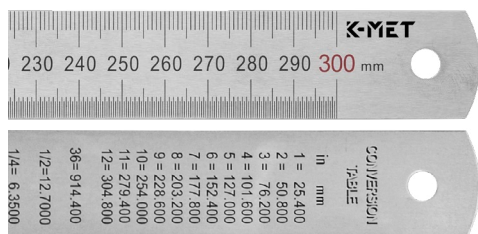

0,5

CODE	L [mm]	s [mm]	t [mm]
1022-02-030	300	25	1
1022-02-050	500	30	1
1022-02-100	1000	30	1

Měřítka ocelové tenké, laserový popis
Steel Thin Ruler, laser marking
Przymiar kreskowy elastyczny, opis laserowy

1



CODE	L [mm]	s [mm]	t [mm]
1022-0	150	13	0,5
1022-1	200	13	0,5
1022	300	25	1,0
1023	500	30	1,0
1024	1000	38	2,0
1025	1500	38	2,0
1026	2000	40	2,0

Měřítka ocelové ohebné BLACK COAT, laser. popis
Steel Thin Ruler BLACK COAT, laser marking
Przymiar kreskowy półsztywny BLACK COAT, opis laser.

1

I
class



CODE	L [mm]	s [mm]	t [mm]
1017-02-015	150	13	0,5
1017-02-030	300	13	0,5
1017-02-050	500	20	0,5
1017-02-100	1000	20	0,5
1017-02-150	1500	20	0,5
1017-02-200	2000	20	0,5



CODE	L [mm]	s [mm]	t [mm]
1017-05-015	150	13	0,5
1017-05-030	300	13	0,5
1017-05-050	500	15	0,5
1017-05-100	1000	20	0,5

Měřítka ocelové ohebné, laserový popis
Flexible Steel Ruler, laser marking (suitable for calibration)
Przymiar kreskowy półsztywny, opis laserowy

1



CODE	L [mm]	s [mm]	t [mm]
1017	300	13	0,5
1018	500	15	0,5
1019	1000	20	0,5
1020	1500	20	1,2
1021	2000	20	1,2

Pravítka | Straight Edges | Liniály

Pravítko kontrolní (k měření rovinnosti), popis laserem
 Precision Straight Edge (for measuring flatness), laser marking
 Liniál kontrolny do pomiaru płaskości, opis laserowy

DIN
874

K-MET

DIN 874 - 0. 500
code 1039-02-050

BEZ POVRCHOVÉ ÚPRAVY | WITHOUT FINISH | NIEPOWLEKANE

0
class

CODE	L [mm]	s [mm]	t [mm]
1039-02-050	500	50	10
1039-02-075	750	50	10
1039-02-100	1000	60	12
1039-02-150	1500	70	15
1039-02-200	2000	80	15
1039-02-250	2500	100	16

I
class

CODE	L [mm]	s [mm]	t [mm]
1039-12-050	500	40	8
1039-12-075	750	50	10
1039-12-100	1000	50	10
1039-12-150	1500	60	12
1039-12-200	2000	70	15
1039-12-250	2500	100	16

II
class

CODE	L [mm]	s [mm]	t [mm]
1039-22-050	500	30	6
1039-22-075	750	40	8
1039-22-100	1000	40	8
1039-22-150	1500	50	10
1039-22-200	2000	60	12
1039-22-250	2500	70	15
1039-22-300	3000	80	15

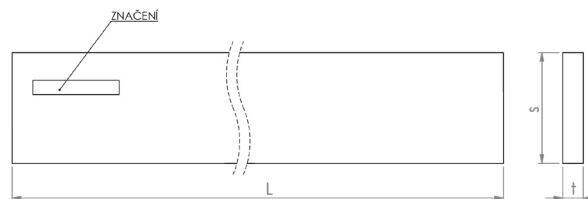

DALŠÍ ROZMĚRY NA ZAKÁZKU
 OTHER SIZES ON REQUEST
 INNE WYMIARY NA ZAMÓWIENIE

Pravítko kontrolní (k měření rovinnosti), popis laserem
 Precision Straight Edge (for measuring flatness), laser marking
 Liniál kontrolny do pomiaru płaskości, opis laserowy

DIN
874

K-MET

DIN 874 - 0. 500
code 1039-02-050

NEREZ OCEL | STAINLESS STEEL | STAL NIERDZEWNA

I
class

CODE	L [mm]	s [mm]	t [mm]
1039-17-050	500	40	8
1039-17-075	750	50	10
1039-17-100	1000	50	10
1039-17-150	1500	60	12
1039-17-200	2000	60	12
1039-17-250	2500	80	15

INOX



DALŠÍ TŘÍDY PŘESNOSTI NA ZAKÁZKU
 OTHER ACCURACY CLASSES ON REQUEST
 INNE KLASY DOKŁADNOŚCI NA ZAMÓWIENIE

Pravítka | Straight Edges | Liniały

Pravítko kontrolní odlehčené (k měření rovinnosti)
Precision Lightened Straight Edge (for measuring flatness)
Lekki liniał do kontroli płaskości

II
class

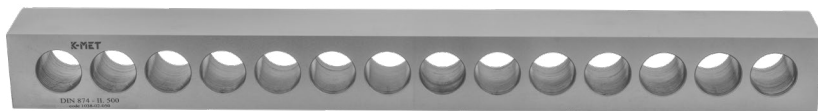

CODE	↔
1038-02-050	50x50x500 mm
1038-02-100	50x50x1000 mm
1038-02-150	50x50x1500 mm

DALŠÍ ROZMĚRY NA ZAKÁZKU | OTHER SIZES ON REQUEST | INNE WYMIARY NA ZAMÓWIENIE

Pravítko mostové kontrolní - litinové
Bridge Type Straight Edge - cast iron
Liniał powierzchniowy żebrowany - żeliwo

DIN
876



CODE	↔
I class 1033-12-050	500x40 mm
1033-12-075	750x45 mm

CODE	↔
II class 1033-22-100	1000x50 mm
1033-22-150	1500x60 mm
1033-22-200	2000x70 mm

Pravítko nožové kalené
Knife Edge Straight Edge
Liniał krawędziowy hartowany

DIN 874-2 **00** class



NEREZOVÁ OCEL | STAINLESS STEEL | STAL NIERDZEWNA

00 class

CODE	↔
1061-05-075	75x25x5 mm
1061-05-100	100x25x5 mm
1061-05-125	125x25x5 mm
1061-05-150	150x25x5 mm
1061-05-200	200x29x7 mm
1061-05-300	300x29x7 mm
1061-05-400	400x33x10 mm
1061-05-500	500x33x10 mm

00 class

CODE	↔
1061-07-075	75x25x5 mm
1061-07-125	125x25x5 mm

- » kalené na 55HRC a broušené
- » funkční plochy lapované
- » ochranná izolace proti přechodu tepla

- » 55HRC hardened and grinded
- » functional surfaces lapped
- » thermal insulation

- » 55HRC hartowane i szlifowane
- » funkcjonalne powierzchnie docierane
- » izolacja termiczna

Příměrné desky a stoly | Surface Plates, Tables | Płyty traserskie i stoly

Příměrná deska granitová, jemně lapovaná diamantem
 Granite Surface Plate, gently lapped with diamond
 Płyty pomiarowe granitowe

DIN
876/0



DALŠÍ ROZMĚRY NA ZAKÁZKU
 OTHER SIZES ON REQUEST
 INNE WYMIARY NA ZAMÓWIENIE

CODE		↔
1041-02-030		300x300x70 mm
1041-02-040		400x400x100 mm
1041-02-063		630x400x100 mm
1041-02-100		1000x630x150 mm
1041-02-120		1200x800x150 mm
1041-02-160		1600x1000x200 mm
1041-02-210		2000x1000x250 mm
1041-02-216		2000x1600x300 mm

Příměrná deska litinová
 Cast Iron Surface Plate
 Płyty traserskie żeliwne



Pro dosažení přesnosti
 je třeba ustavit desku na stolu K-MET.

To achieve accuracy it is necessary
 to set the plate on the K-MET table.

Aby osiągnąć dokładność konieczne
 jest ustawienie płyty na stole K-MET.

DALŠÍ ROZMĚRY NA ZAKÁZKU
 OTHER SIZES ON REQUEST
 INNE WYMIARY NA ZAMÓWIENIE

CODE		↔
1042-02-030		300x300x65mm
1042-02-040		400x400x65mm
1042-02-060		600x450x75mm
1042-02-080		800x600x85mm
1042-02-100		1000x800x105mm
1042-02-120		1200x800x160mm

Stůl pod granitovou desku PROFI - svařované z jeklu, lakované
 Table for Granite Surface Plate - welded hollow, lacquered
 Stoły PROFI do płyt granitowych, spawane, malowane



Podstavec litinové desky PROFI - svařované z jeklu, lakované
 Table for Cast Iron Surface Plate - welded hollow, varnished
 Stoły PROFI do płyt żeliwnych, spawane, malowane



CODE		↔	pro pre dla
1041-12-040		224x224x700 mm	1041-02-040
1041-12-063		355x224x700 mm	1041-02-063
1041-12-100		560x355x700 mm	1041-02-100
1041-12-120		675x450x700 mm	1041-02-120
1041-12-160		900x560x700 mm	1041-02-160
1041-12-210		1600x600x650 mm	1041-02-210

CODE		↔	pro pre dla
1042-12-030		300x300x600 mm	1042-02-030
1042-12-040		400x400x600 mm	1042-02-040
1042-12-060		600x450x600 mm	1042-02-060
1042-12-080		800x600x600 mm	1042-02-080
1042-12-100		1000x800x600 mm	1042-02-100
1042-12-120		1200x800x750 mm	1042-02-120

Příměrné desky a stoly | Surface Plates, Tables | Płyty traserskie i stoly

Granitový kontrolní úhelník 90°
Precision Granite Square 90°
Kątownik kontrolny granitowy 90°



GRANITOVÉ KOSTKY A ÚHELNÍKY
BROUSÍME A DODÁVÁME NA ZAKÁZKU

GRANITE CUBES AND SQUARES
GRIND AND DELIVER TO ORDER

GRANITOWE KOSTKI, TRÓJKĄTY
I KWADRATY SZLIFUJEMY I
DOSTARCZAMY W RÓŻNYCH
ROZMIARACH
NA ŻYCZENIE KLIENTA



CODE	
1041-80	100x63x16 mm
1041-82	160x100x20 mm
1041-84	250x160x25 mm
1041-86	400x250x40 mm
1041-88	630x400x80 mm
1041-90	1000x630x80 mm

Na vyžádání nabízíme i verzi s garantovanou přesností všech měrných ploch od 0,2 μm.

Upon request, we also offer a version with a guaranteed accuracy of all measurement areas from 0,2 μm.

Na życzenie oferujemy również wersję z gwarantowaną dokładnością wszystkich powierzchni pomiarowych od 0,2 μm.

Rýsovací podložky | V - blocks | Pryzmy pomiarowe

Rýsovací podložky se zářezy - dodáváno v páru, kaleno na 60 HRC

V - BLOCKS (Pair), hardened to 60 HRC

Pryzmy pomiarowe z wycięciami - dostarczamy w parach, hartowane do 60 HRC



S JEDNÍM ZÁŘEZEM | 1 SLOT | Z JEDNYM WYCIĘCIEM

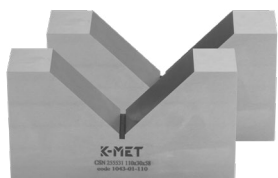

CODE	L	S	V	Z	α
1043-01-110	110	30	58	70	90°
1043-01-140	140	40	80	90	90°
1043-01-200	200	55	120	130	90°

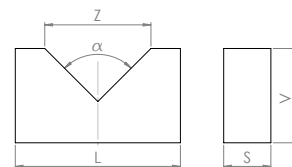

SE DVĚMA ZÁŘEZY | 2 SLOTS | Z DWOMA WYCIĘCIAMI

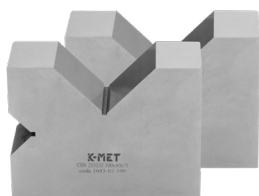

CODE	L	S	V	Z	Z1	α
1043-02-100	100	40	75	50	24	90°
1043-02-140	140	55	100	70	30	90°
1043-02-180	180	70	130	90	50	90°

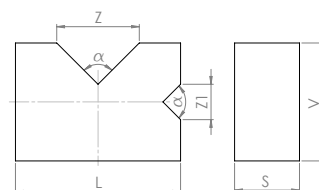

SE ČTYŘMI ZÁŘEZY | 4 SLOTS | Z CZTEREMA WYCIĘCIAMI



CODE	L	S	V	Z	Z1	Z2	Z3	α
1043-03-070	70	20	50	40	24	16	10	90°
1043-03-130	130	50	110	70	50	30	16	90°
1043-03-200	200	80	170	110	70	50	30	90°

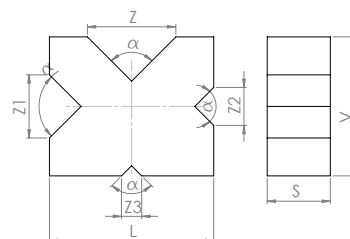

Na zakázku dodáváme i v provedení s magnetem.

We also supply version with magnets on request.

Dostarczamy również wykonane na zamówienie z magnesem.



Podpěrky

Support Props for general use

Podpórka



3034



3035 - 3037

CODE	výška height wysokość	nosnost load cap. pojemność	sestava set zestaw
3034	63 mm		1 hlava 1 head 1 główka
3035	80 mm	14 000 N	sada hrotů tips set
3036	145 mm	45 000 N	
3037	205 mm	70 000 N	zestaw wskaźówek

Měrky | Slip & Pin Gauge Sets | Szczelinomierze

Základní ocelové měrky
Steel Slip Gauge Sets
Komplet płytek wzorcowych

**NEW
LINE**



Sestava měrek | Gage Set | Zestawy :
http://www.k-met.com/SESTAVA_MERЕК.pdf

0
class

CODE	ks	pcs	szt
1046-03-038		38	
1046-03-047		47	
1046-03-083		83	
1046-03-087		87	
1046-03-103		103	
1046-03-112		112	
1046-03-122		122	

I
class

CODE	ks	pcs	szt
1046-13-038		38	
1046-13-047		47	
1046-13-083		83	
1046-13-087		87	
1046-13-103		103	
1046-13-112		112	
1046-13-122		122	

Základní keramické měrky
Square Ceramic Gage Block Set
Zestawy płytek wzorcowych ceramicznych

I
class



CODE	ks	pcs	szt
1050-13-032		32	
1050-13-047		47	
1050-13-087		87	
1050-13-103		103	

Válečkové měrky ocelové sada
Steel Pin Gage Set
Komplet wałeczków pomiarowych

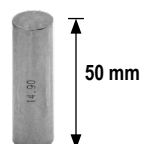

CODE		ks	pcs	szt	
1047-14-001	0,30 - 1,0/0,01 mm		71		2 μm
1047-14-002	1,01 - 2,0/0,01 mm		100		2 μm
1047-14-003	2,01 - 3,0/0,01 mm		100		2 μm
1047-14-004	3,01 - 4,0/0,01 mm		100		2 μm
1047-14-005	4,01 - 5,0/0,01 mm		100		2 μm
1047-14-006	5,01 - 6,0/0,01 mm		100		2 μm
1047-14-007	6,01 - 7,0/0,01 mm		100		2 μm
1047-14-008	7,01 - 8,0/0,01 mm		100		2 μm
1047-14-009	8,01 - 9,0/0,01 mm		100		2 μm
1047-14-010	9,01 - 10,0/0,01 mm		100		2 μm
1047-13-003	0,30 - 3,0/0,10 mm		28		2 μm
1047-13-005	1,00 - 5,0/0,10 mm		41		2 μm
1047-13-010	5,0 - 10,0/0,10 mm		51		2 μm
1047-13-015	10,0 - 15,0/0,10 mm		51		2 μm
1047-13-020	15,0 - 20,0/0,10 mm		51		2 μm

Lupy | Magnifying Glasses | Lupy

Hodinářská lupa s plastovou čočkou 24 mm
 Brinell Magnifying Glass 24 mm
 Lupa zegarmistrzowska 24mm



CODE

1094-1	x3
1094-2	x4
1094-3	x6

Lupa s mm stupnicí
 Magnifier with mm scale
 Lupa ze skalą mm

Lupa s mm stupnicí a LED osvětlením, 15x, USB
 Magnifier with mm scale and LED lighting, 15x, USB
 Lupa ze skalą w mm i oświetleniem LED, 15x, USB



CODE

CODE		
1094-04-008	x8	0,1 mm
1094-04-010	x10	0,1 mm



CODE

CODE		
1094-14-015	x15	0,1 mm

Tloušťkoměry | Thickness Gauges | Mierniki grubości

Digitální tloušťkoměr vrstev (na měření tloušťky vrstvy barev, povlaků, fólií)
 Digital layer Thickness Gauge (for measuring the thickness of layers of paints, coatings, foils)
 Cyfrowy miernik grubości warstw (do pomiaru grubości warstw farb, powłok, folii)



CODE

CODE		— —
7900-05-125	0-999 μm: 0,1 μm, >1000 μm: 1 μm.	0 - 1250 mm
7900-05-150	0-999 μm: 0,1 μm, >1000 μm: 1 μm.	0 - 1500 mm

Úhlooměry | Protractors | Kątomierze

Úhloměr digitální 0 - 360°
Digital Universal Bevel Protractor with magn. glass & rules, 0 - 360°
Kątomierz elektroniczny 0 - 360°

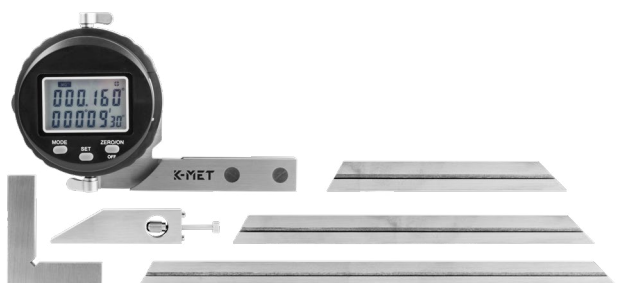

CODE		
1093-20	0 - 360°	1' (0,01°)

Úhloměr s lupou a pravítky 0 - 360°
Universal Bevel Protractor with Magnifier and rulers 0 - 360°
Kątomierz z lupą 0 - 360°

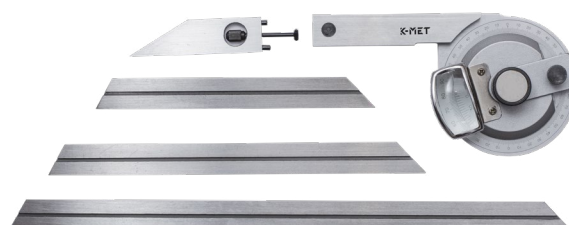

CODE		
1093	0 - 360°	5' (0,08°)

Úhloměr obloukový 180°
Protractor 0 - 180°
Kątomierz traserski 180°

CODE	↔
1089-02-120	120x200 mm
1089-02-200	200x290 mm
1089-02-250	250x400 mm

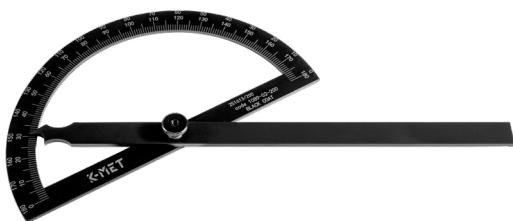

Úhloměr obloukový 180° - NEREZ
Protractor 0 - 180° - STAINLESS STEEL
Kątomierz traserski 180° - STAL NIERDZEWNA

INOX

CODE	↔
1089-07-120	120x200 mm
1089-07-200	200x290 mm
1089-07-250	250x400 mm
1089-07-315	315x650 mm

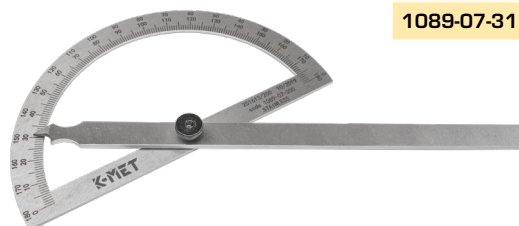

Úhloměr pro tesaře digitální
Digital Protractor for Carpenters
Kątomierz traserski elektroniczny

CODE	
1092-02-268	0,05°



Měrky | Templates | Szczelinomierze

Měřidlo výšky dezénu pneumatik - digitální
 Digital Tyre Gauge
 Elektroniczny miernik wysokości bieżnika opon



CODE		
1119-10	0 - 25 mm / 0-1"	± 0,2 mm

Měrka koutových svarů
 Welding Gauge
 Spoinomierze

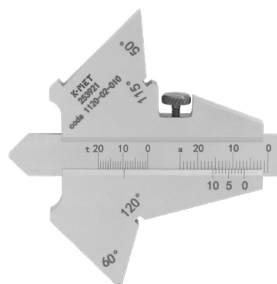

CODE	
1120-02-010	50°, 60°, 115°, 120°

Šablona na koutové svary, 1-5
 Welding Gauge, 1 - 5
 Szablon spawu kątownego 1-5



CODE	
1120-02-012	1 - 5

Měrka na svary - CAMBRIDGE
 Cambridge Welding Gauge
 Miernik spawu - CAMBRIDGE



CODE	
1120-02-013	

Měrka svarová háková
 Pipe Welding Gauge
 Miernik spawu - hak

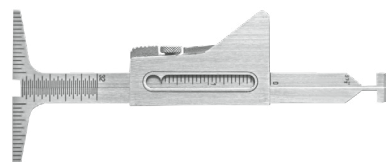

CODE	
1120-02-014	

Měrky | Templates | Szczelinomierze

Měrka na svary - 3 stupnice
Welding Gauge - 3 scales
Miernik spawu - 3 skale

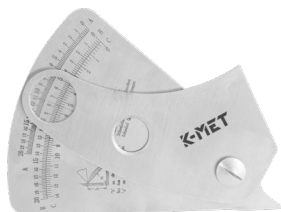

CODE

1120-02-015

Měrka koutových svarů, digitalální
Digital Welding Gauge
Spoimierz digitalny



CODE

1120-05-011 60°,70°,80°,90° 0 - 20 mm 0,01 mm

Měrka koutových svarů, analog, nerez
Welding Gauge
Spoimierz analogowy, stal nierdzewna

INOX

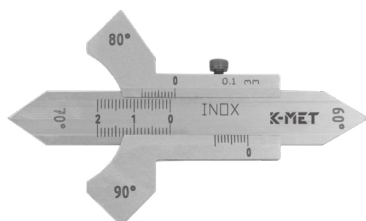

CODE

1120-07-020 60°,70°,80°,90° 0 - 20 mm 0,1 mm

Měrka zbrošení vrtáku
Twist Drill Grinding Gauge
Szablon do wiertel

CODE

1121 40°, 50°, 60°, 70°,
80°, 90°, 100°, 110°,
120°, 130°, 140°



Šablona pro závit
Thread Gauge
Wzorce gwintów

INOX



1122



1123



1124



1126

CODE

1122	Whitworth 55°
1123	metrický metric metryczny 60°
1124	Trapéz 2 - 12 mm, 30°
1126	univerzální universal uniwersalny

Šablona na měření úhlů soustružnických noží
Template for measuring Turning Tools
Szablon do mierzenia kątów noży w tokarce

CODE

1127



Měrky | Templates | Szczelinomierze

Měrka nemagnetická - sada (mosaz)
 Nonmagnetic Feeler Gauge Set (brass)
 Szczelinomierz niemagnetyczny - zestaw (mosiądz)



Měrka ventilová - sada
 Feeler Gauge Set
 Szczelinomierz - zestaw



CODE		ks	pcs	szt.
1129-1	0,05 - 1 mm	100 mm	20	

CODE		ks	pcs	szt.
1130	0,02 - 0,2 mm	100 mm	10	
1131	0,05 - 1 mm	100 mm	20	
1131-02-032	0,03 - 1 mm	100 mm	32	
INOX 1131-07-020	0,05 - 1 mm	100 mm	20	
1132	0,05 - 1 mm	200 mm	20	
1132-02-013	0,05 - 1 mm	200 mm	13	
1133	1 - 2 mm	200 mm	11	
1133-02-020	0,1 - 2mm	200 mm	20	

Měrka ventilová v dóze
 Feeler Gauge Tape
 Szczelinomierz taśmowy



CODE		CODE	
1134-0,01/D	0,01 mm 5000x13 mm	1134-0,30/D	0,3 mm 5000x13 mm
1134-0,02/D	0,02 mm 5000x13 mm	1134-0,35/D	0,35 mm 5000x13 mm
1134-0,03/D	0,03 mm 5000x13 mm	1134-0,40/D	0,4 mm 5000x13 mm
1134-0,04/D	0,04 mm 5000x13 mm	1134-0,45/D	0,45 mm 5000x13 mm
1134-0,05/D	0,05 mm 5000x13 mm	1134-0,50/D	0,5 mm 5000x13 mm
1134-0,06/D	0,06 mm 5000x13 mm	1134-0,55/D	0,55 mm 5000x13 mm
1134-0,07/D	0,07 mm 5000x13 mm	1134-0,60/D	0,6 mm 5000x13 mm
1134-0,08/D	0,08 mm 5000x13 mm	1134-0,65/D	0,65 mm 5000x13 mm
1134-0,09/D	0,09 mm 5000x13 mm	1134-0,70/D	0,7 mm 5000x13 mm
1134-0,10/D	0,1 mm 5000x13 mm	1134-0,75/D	0,75 mm 5000x13 mm
1134-0,12/D	0,12 mm 5000x13 mm	1134-0,80/D	0,8 mm 5000x13 mm
1134-0,15/D	0,15 mm 5000x13 mm	1134-0,85/D	0,85 mm 5000x13 mm
1134-0,18/D	0,18 mm 5000x13 mm	1134-0,90/D	0,9 mm 5000x13 mm
1134-0,20/D	0,2 mm 5000x13 mm	1134-0,95/D	0,95 mm 5000x13 mm
1134-0,25/D	0,25 mm 5000x13 mm	1134-1,00/D	1 mm 5000x13 mm

Měrky | Templates | Szczelinomierze

Kuželový klínek
Round Taper Gauge
Klin stożkowy



CODE		
1138-12-006	1 - 6 mm	0,1
1138-12-015	4 - 15 mm	0,1

Kuželová měrka
Taper Gauge
Wskaźnik stożkowy



CODE		
1138-02-015	1 - 15 mm	0,1
1138-02-030	15 - 30 mm	0,1
1138-02-045	30 - 45 mm	0,1
1138-02-060	45 - 60 mm	0,1

Měrka radiusová - sada
Radius Gauge Set
Wzorce łuków - zestaw



CODE		ks pcs szt.
1140	r 1 - 7 mm	34
1141	r 7,5 - 15 mm	32
1142	r 15,5 - 25 mm	30

Měrka závitová
Screw Gauge Set
Wzorce zarysu gwintu



CODE		ks pcs szt.	
1146	0,4 - 7 mm	20	Metric
1147	4 - 62 mm	28	Whitworth
1148	0,25 - 6 / 4 - 62 / 8 - 28 mm	58	M + W + G
1148-02-014	10 - 40 mm	14	US
1148-02-016	12 - 80 mm	16	UNF
1148-02-020	4 - 26 mm	20	BSF
1148-02-022	4 - 64 mm	22	UNC
1148-02-030	4 - 42 mm	30	US

Posuvné měřítko na měření zkosení hran 45°
Caliper for chamfer 45°
Suwmiarka do pomiaru fazowania 45°

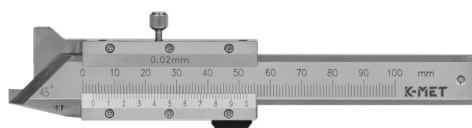

CODE	
1128-02-007	0 - 70 mm

Šablona pro broušení vrtáku
Template for Grinding Drill
Szablon do ostrzenia wiertel

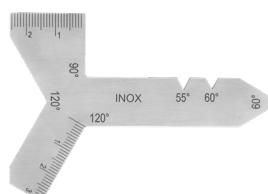

CODE	
1125	55°, 60°

Stojánky | Stands | Podstawki

Stojánek magnetický UMAG
Magnetic Stand UMAG
Podstawka magnetyczna UMAG

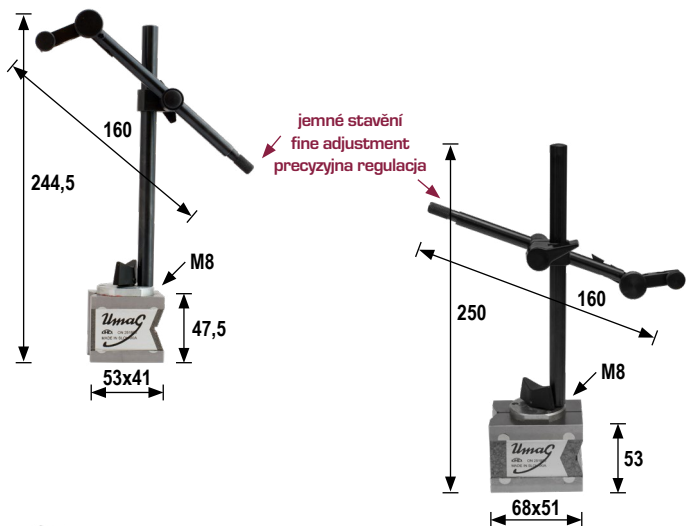

CODE	v papírovém obalu in paper case opakowanie AL	
1150	PN 25 1858.1	294 N
1151	PN 25 1858.2	800 N



CODE	v luxusním AL obalu in luxury AL case luksusowe AL opakowanie	
1150-1	PN 25 1858.1	294 N
1151-1	PN 25 1858.2	800 N

Stojánek magnetický UMAG, papírový obal
Magnetic Stand UMAG, paper wrapper
Podstawka magnetyczna UMAG, opakow. papierowe



CODE

1150-5	velký kloub large joint duży przegub	160 mm	294 N
1150-6	ekonomický economic ekonomiczny	160 mm	294 N
1150-7	ohebný kloub flexible elastyczny przegub	360 mm	294 N

Stojánek magnetický UMAG - PROFI, papírový obal
Magnetic Stand UMAG - PROFI, paper wrapper
Podstawka magnetyczna UMAG - PROFI, opakow. papierowe

CODE

1150-61	294 N
1151-61	800 N



1150-61
1151-61

Stojánky | Stands | Podstawki

Měřicí granitový stojánek
Granite Stand with Arm
Precyzyjny stolik pomiarowy

**NEW
LINE**

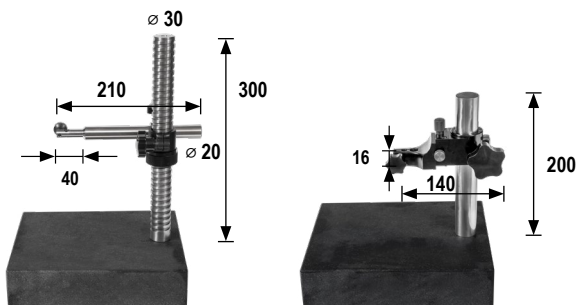

1150-04-250

1150-05-250

CODE

1150-04-250 250x200x65 mm

1150-05-250 250x200x65 mm

Měřicí stůl s jemným stavěním
Granite Stand with Fine Adjustment
Precyzyjny stolik pomiarowy z regulowanym remieniem

**NEW
LINE**

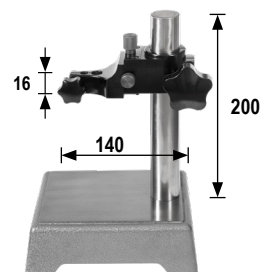

1150-07-150

CODE

1150-07-150 150x150 mm

Stojánek
Stand
Podstawka

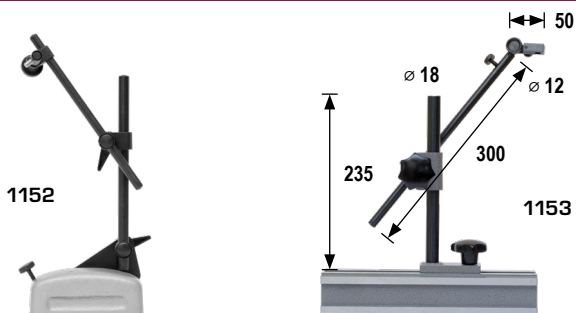

1152

1153

CODE

1152 upínací | clamping | zaciskanie \varnothing 8 mm PN 25 1867 180 mm

1153 upínací | clamping | zaciskanie \varnothing 8 mm PN 25 1857 180 mm

Stojánek na mikrometry
Holder for Micrometer
Podstawka dla mikrometrów



1160

CODE

1160 170x117x120 mm

1160-02-117 125x90x65 mm



1160-02-117

Úchylkoměry | Indicators | Czujniki

3D sonda
3D Probe
Sonda 3D



CODE

1155-23-030

Najjžděcí nulovací kostka
Zero adjusters with integrated dial indicator
Kostka zerująca



CODE

1155-20-050 bez magnetu | without magnet | bez magnesu

1155-28-050 s magnetem | with a magnet | z magnesem

Úchylkoměry | Indicators | Czujniki

Úchylkoměr číselníkový TOP QUALITY (vhodný pro kalibrace)
Dial Indicator TOP QUALITY (recommended for calibration)
Czujnik zegarowy - TOP QUALITY (nadaje się do kalibracji)

Úchylkoměr číselníkový - s uchycením
Dial Indicator with lug
Czujnik zegarowy - z mocowaniem

0,01

DIN
878

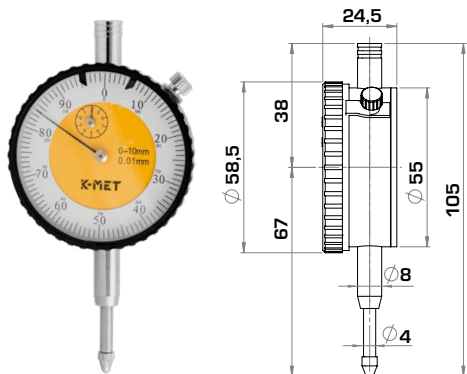

0,01

DIN
878

CODE



1155-02-110 0 - 10 mm 0,01 mm M 2,5

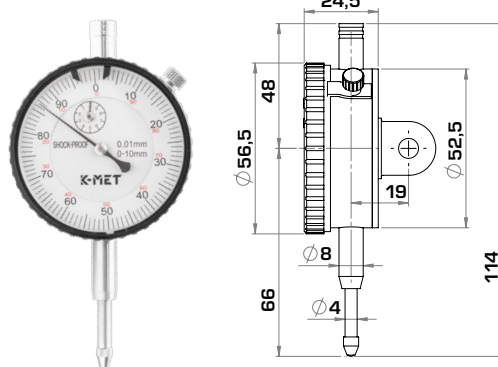

CODE



1155-02-410 0 - 10 mm 0,01 mm M 2,5

1155-02-710 0 - 10 mm 0,01 mm M 2,5

1155-02-710
odolný proti nárazu
shock-proof
wstrząsoodporny

Úchylkoměr číselníkový
Dial Indicator
Czujnik zegarowy

0,001

0,01

DIN
878

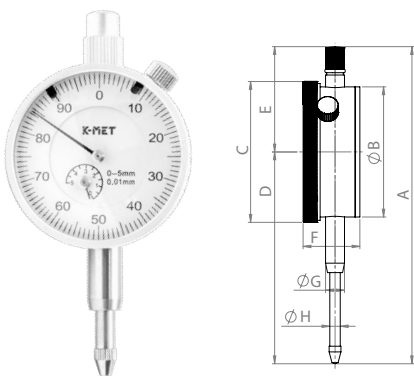

CODE



A

B

C

D

E

F

G

H

CODE	Range	Resolution	A	B	C	D	E	F	G	H	Mounting
1155-02-010	0 - 10 mm	0,01 mm	114	52,5	56,5	66	48	24,5	8	4	M 2,5
1155-02-001	0 - 1 mm	0,001 mm	104	53,5	57	61	43	23,5	8	4	M 2,5
1155-02-025	0 - 25 mm	0,01 mm	122	55	58	85	37	25,5	8	5	M 2,5
1155-02-030	0 - 30 mm	0,01 mm	126	55	58	89	37	25,5	8	5	M 2,5
1155-02-005	0 - 5 mm	0,01 mm	85	39,5	42,5	50	35	21	8	4	M 2,5

Úchylkoměr číselníkový páčkový
Dial Test Indicator
Czujnik zegarowy - Diatest

0,002

0,01

DIN
2270

HORIZONTÁLNÍ | HORIZONTAL | POZIOMY

CODE	Range	Resolution	d	A	B	C	D	E	F	Mounting
1156-02-010	± 0,8 mm	0,01 mm	39	6,2	17	17	48	63	9	M 2
1156-02-102	± 0,2 mm	0,002 mm	32,5	7	17	17	43	57	9	M 2
1156-02-222	± 0,8 mm	0,01 mm	39	6,2	17	17	48	63	9	M 2

1156-02-222 - karbidový hrot | carbide point | trzpień węglukowy

VERTIKÁLNÍ | VERTICAL | PIONOWY

CODE	Range	Resolution	d	A	B	D	E	Mounting
1156-02-110	± 0,8 mm	0,01 mm	40	6	13	57	71	M 2

průměr kuličky | ball diameter | średnica kulki 2 mm

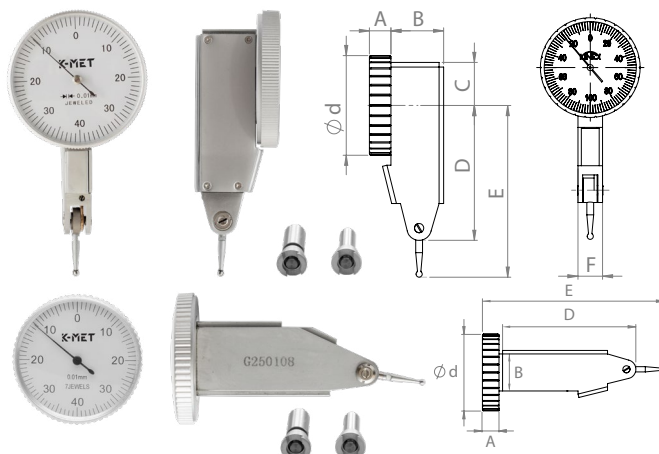

Úchylkoměry | Indicators | Czujniki

Úchylkoměr číselníkový digitální ABSOLUTE ZERO, MAX/MIN, vhodné pro kalibrace
 Digital Indicator ABSOLUTE ZERO, MAX/MIN (recommended for calibration)
 Czujnik zegarowy elektroniczny ABSOLUTE ZERO, MAX/MIN, nadaje się do kalibracji



0,001

0,01



1155-05-001

CODE		D	
1155-05-010	0 - 12,7mm	60	0,01 mm M 2,5
1155-05-001	0 - 12,7mm	60	0,001 mm M 2,5



1155-35-010

CODE		B	C	ø	
1155-35-010	0 - 12,7 mm	88,5	142,0	8 mm	0,01 mm M 2,5
1155-35-001	0 - 12,7 mm	88,5	140,5	8 mm	0,001 mm M 2,5

Úchylkoměr číselníkový digitální
 Digital Indicator
 Czujnik zegarowy elektroniczny



0,001

0,01



CODE		
1155-25-010	0 - 12,7 mm	0,01 mm M 2,5
1155-25-001	0 - 12,7 mm	0,001 mm M 2,5

Úchylkoměry | Indicators | Czujniki

Úchylkoměr ICONIC LABO číselníkový digitální s Bluetooth
 Digital Indicator ICONIC LABO, metal housing, Bluetooth
 Czujnik zegarowy ICONIC LABO elektroniczny, Bluetooth



1155-952-0005

1155-95-010

1155-95-0005

- » Ochrana **IP54**
- » „Absolute origin“ systém měření
- » Rychlost odezvy není omezena
- » **Integrovaný Bluetooth modul**
- » API pro připojení softwarových aplikací
- » Funkce (HOLD, Preset, ±, mm/inch)

- » **IP54 protection**
- » „Absolute origin“ measurement system
- » Response speed is not limited
- » **Integrated Bluetooth module**
- » API for connecting software applications
- » Functions (HOLD, Preset, ±, mm/inch)

- » Stopień ochrony **IP54**
- » System mierzenia: Absolute origin
- » Szybkość odpowiedzi nie jest ograniczona
- » **Zintegrowany moduł Bluetooth**
- » API do łączenia aplikacji programowych
- » Funkcje (HOLD, Preset, ±, mm/cal)

BLUETOOTH PROFILE



Bezdrátový přenos dat přes Bluetooth jako zařízení standardu HID, není potřeba žádný další software.

Wireless data transfer via Bluetooth, connect as HID standard device, no additional software is needed.

Bezprzewodowa transmisja danych przez Bluetooth jako standardowe urządzenie HID.

CODE			
1155-95-010	0 - 12,7 mm	0,01 mm	M 2,5
1155-95-0005	0 - 12,7 mm	0,0005 mm	M 2,5
1155-951-0005	0 - 25,4 mm	0,0005 mm	M 2,5
1155-952-0005	0 - 50,8 mm	0,0005 mm	M 2,5

Digitální měřidlo rádiusu
 Digital radius gauge
 Cyfrowy miernik promienia



CODE		
1155-25-705	5 - 700 mm	0,005 mm

Digitální indikátor
 Digital Test Indicator
 Cyfrowy wskaźnik testowy



CODE		
1156-05-001	0 - 0,8 cm	0,001 mm

Úchylkoměry | Indicators | Czujniki

Náhradní dotyky k úchylkoměrům
 Probe Tips
 Zestawy wymiennych końcówek do czujników



CODE

1155-7 M 2,5 mm sada 22 ks
 set 22 pcs
 zestaw 22 szt.

Měřicí můstek k digitálním úchylkoměrům
 Measuring Bridge for Digital Digital Indicators
 Mostek pomiarowy dla czujnika zegarowego (tylko elektroniczny)

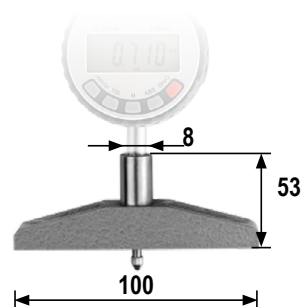

CODE

1155-00-100

Výškoměry | Height Gauges | Wysokościomierze

Výškoměr analogový
 Height Gauge
 Wysokościomierz suwmiarkowy

0,02

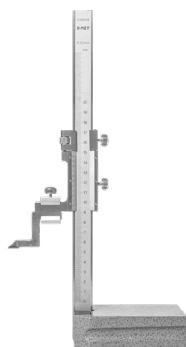

CODE

CODE	Range
3014-02-020	0 - 200 mm
3014-02-030	0 - 300 mm
3014-02-050	0 - 500 mm
3014-02-100	0 - 1000 mm

Výškoměr digitální
 Digital Height Gauge
 Wysokościomierz suwmiarkowy z odczytem cyfrowým

0,01



CODE

CODE	Range
3022-05-020	0 - 200 mm
3022-05-030	0 - 300 mm
3022-05-050	0 - 500 mm
3022-05-060	0 - 600 mm
3022-05-080	0 - 800 mm
3022-05-100	0 - 1000 mm

Výškoměr digitální s dvojitým ramenem
 Digital Double Column Height Gauge
 Wysokościomierz elektroniczny kolumnowy

0,01



CODE

CODE	Range
3020-02-030	0 - 300 mm
3020-02-050	0 - 500 mm
3020-02-060	0 - 600 mm

Hloubkoměry | Depth Gauges | Głębokościomierze

Hloubkoměr bez nosu
Vernier Depth Gauge
Głębokościomierz bez nosa

0,02

ČSN
25 1280

DIN
862

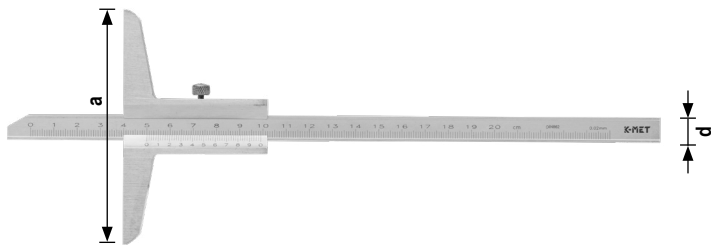

CODE	Range	a [mm]	d [mm]	Resolution
2034-02-150	0 - 150 mm	100	11	0,02 mm
2034-02-200	0 - 200 mm	100	11	0,02 mm
2034-02-300	0 - 300 mm	100	11	0,02 mm
2034-02-500	0 - 500 mm	125	11	0,02 mm

Hloubkoměr s nose
Vernier Depth Gauge with Nose
Głębokościomierz z nose

0,02

ČSN
25 1282

DIN
862

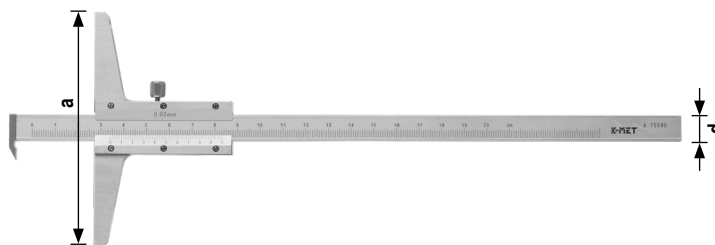

CODE	Range	a [mm]	d [mm]	Resolution
2040-02-150	0 - 150 mm	100	11	0,02 mm
2040-02-200	0 - 200 mm	100	11	0,02 mm
2040-02-250	0 - 250 mm	100	11	0,02 mm
2040-02-300	0 - 300 mm	100	11	0,02 mm
2040-02-500	0 - 500 mm	100	11	0,02 mm

Hloubkoměr digitální bez nosu
Digital Depth Gauge
Głębokościomierz elektroniczny bez nosa

0,01

DIN
862

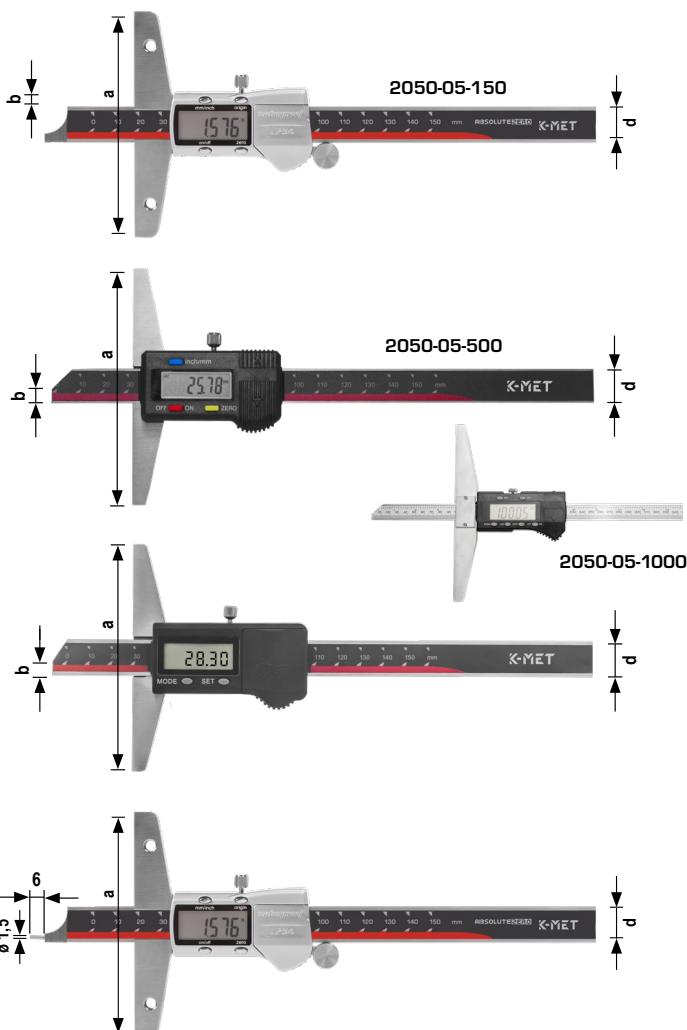

CODE	Range	a [mm]	b [mm]	d [mm]	Resolution
2050-05-150	0 - 150 mm	100	4	16	0,01 mm
2050-05-200	0 - 200 mm	100	4	16	0,01 mm
2050-05-300	0 - 300 mm	100	4	16	0,01 mm

CODE	Range	a [mm]	b [mm]	d [mm]	Resolution
2050-05-500	0 - 500 mm	120	7	15	0,01 mm
2050-05-600	0 - 600 mm	120	7	15	0,01 mm
2050-05-800	0 - 800 mm	150	7	18	0,01 mm
2050-05-1000	0 - 1000 mm	200	5	20	0,01 mm



CODE	Range	a [mm]	b [mm]	d [mm]	Resolution
2050-25-150	0 - 150 mm	100	4	14	0,01 mm
2050-25-200	0 - 200 mm	100	4	14	0,01 mm
2050-25-300	0 - 300 mm	100	4	14	0,01 mm

CODE	Range	a [mm]	b [mm]	d [mm]	Resolution
2052-05-150	0 - 150 mm	100	4	14	0,01 mm

Hloubkoměry | Depth Gauges | Głębokościomierze

Hloubkoměr digitální s nosem
Digital Depth Gauge
Głębokościomierz elektroniczny z nosem

0,01

DIN
862

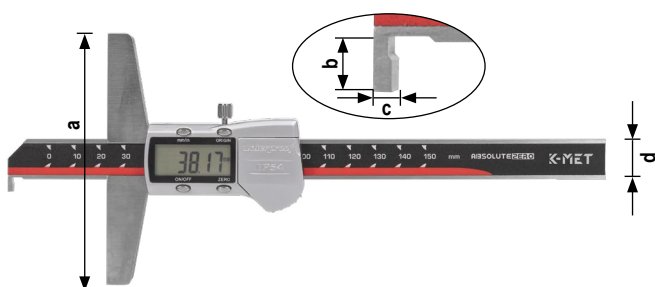

CODE	Range	a [mm]	b [mm]	c [mm]	d [mm]	Resolution
2051-05-150	0 - 150 mm	100	5	2	16	0,01 mm
2051-05-200	0 - 200 mm	100	5	2	16	0,01 mm
2051-05-300	0 - 300 mm	100	5	2	16	0,01 mm
2051-05-500	0 - 500 mm	120	8	3	15	0,01 mm

Kružidla | Spring Bow Dividers | Cyrkle

Kružidlo s pružinou
Spring Bow Divider
Cyrkiel sprężynowy

ČSN
25 5170

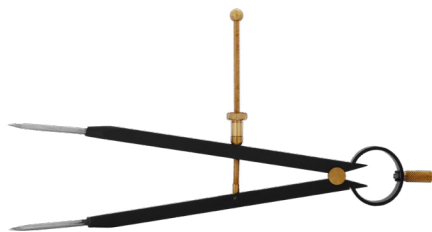

CODE	Range	Length
2070-02-150	6 - 200 mm	150 mm
2070-02-200	10 - 300 mm	200 mm
2070-02-250	10 - 350 mm	250 mm
2070-02-300	10 - 450 mm	300 mm

Kružidlo bez mm dělení
Marking Gauge without mm Scale and Fine Adjustment
Cyrkiel nastawny



CODE	Range	Length
2074	25 - 470 mm	500 mm
2075	25 - 960 mm	1000 mm
2074-1	prodloužení extension przedłużenie	500 mm
2075-1	prodloužení extension przedłużenie	1000 mm

Kružidlo ploché s mm dělením a jemným stavěním
Beam Trammel with 0,1mm graduation, Fine Adjustment
Cyrkiel nastawny z podziałą i precyzerem

DIN
862

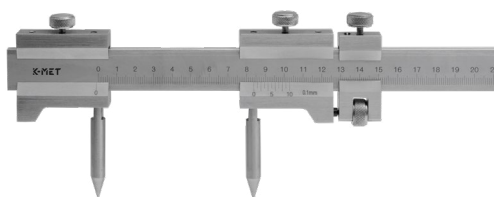

CODE	Range	Resolution
2078	500 mm	0,1 mm
2078-1	1000 mm	0,1 mm
2078-2	1500 mm	0,1 mm
2078-3	2000 mm	0,1 mm

Nádrž
Surface Gauge
Rysik słupkowy traserski

ČSN
25 5315



CODE	Base Length
3001	250 mm
3002	400 mm

Hmatadla | Internal & External Calipers | Cyrkle

Hmatadlo vnější
External Caliper
Macka zewnętrzna

ČSN
25 1210



CODE	Range	Stroke
2001	0 - 250 mm	150 mm
2002	0 - 340 mm	200 mm
2002-1	0 - 250 mm	250 mm
2003	0 - 510 mm	300 mm

Hmatadlo vnější
External Caliper
Macka zewnętrzna

ČSN
25 1212

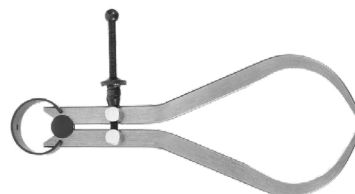

CODE	Range	Stroke
2006	0 - 120 mm	150 mm
2009	0 - 250 mm	300 mm
2010	0 - 350 mm	500 mm

Hmatadlo vnitřní
Internal Caliper
Macka wewnętrzna sprężynowa

ČSN
25 1215



CODE	Range	Stroke
2012	20 - 300 mm	150 mm
2013	25 - 400 mm	200 mm
2014	30 - 600 mm	300 mm

Hmatadlo vnitřní
Internal Caliper
Macka wewnętrzna sprężynowa

ČSN
25 1217



CODE	Range	Stroke
2016	10 - 130 mm	150 mm
2017	12 - 165 mm	200 mm
2018	12 - 205 mm	250 mm
2019	12 - 250 mm	300 mm

Hmatadlo vnější digitální
Digital External Caliper
Macka zewnętrzna elektroniczna

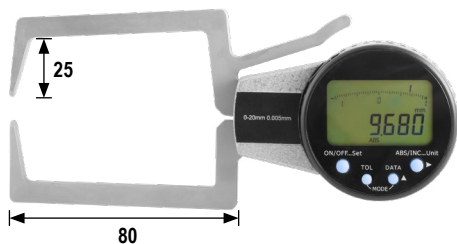

CODE	Range	Resolution	Accuracy
2001-05-020	0 - 20 mm	0,01 mm	0,03 mm
2001-05-040	20 - 40 mm	0,01 mm	0,03 mm
2001-05-060	40 - 60 mm	0,01 mm	0,03 mm

Hmatadlo vnitřní digitální
Digital Internal Caliper
Macka wewnętrzna elektroniczna

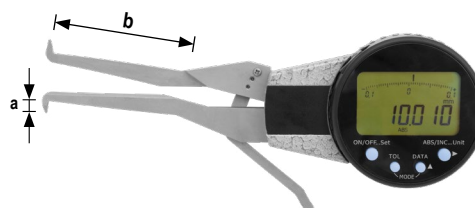

CODE	Range	Resolution	a	b	Accuracy
2012-05-025	5 - 25 mm	0,01 mm	1,5 mm	35 mm	0,03 mm
2012-05-040	20 - 40 mm	0,01 mm	6,5 mm	80 mm	0,03 mm
2012-05-060	40 - 60 mm	0,01 mm	8,5 mm	80 mm	0,03 mm

Rýsovací jehly a tužky | Scribers | Rysiki i ołówki

Rýsovací jehly
Scribers
Rysiki - węglkowe



CODE		Ø	↔
3025	rovná straight równa	ČSN 25 5340.11	5 mm 150 mm
3026	zahnutá bent zakrzywiona	ČSN 25 5340.21	5 mm 200 mm
3026-30	celokarbidová fully carbide monolit		4 mm 160 mm

Rýsovací tužky
Drawing Pencils
Ołówki - węglkowe



CODE		↔
3025-2	s karbidovým hrotem with carbide tip z koňcówką węglkową	150 mm
3025-5	s karbidovým hrotem with carbide tip z koňcówką węglkową	150 mm

Tužka rýsovací na sklo a plech 3263
Pencil for Glass and Sheet Metal, type 3263
Ołówek do trasowania na szkle i blachach 3263



CODE	typ	↔
9038	3262	175 mm

Tužka tesařská
Carpenter Pencil
Ołówek stolarski



CODE	tvrdost tvrdost twardość	typ	↔
9030	1	1536	175 mm
9031	2	1536	175 mm
9033	2	1537	250 mm

Tužka rýsovací na kámen
Pencil for Stone
Ołówek do trasowania kamienia



CODE	typ	↔
9035	1536	175 mm

Vratidla závitníků a závitových oček | Tap Wrenches | Pokrętła do gwint. i oprawy do narzynek

Vratidlo na závitníky pro čtyřhran
Tap Holder
Pokrętła do gwintowników



CODE			#
3040-02-045	2,00 - 4,50 mm	M2 - M7	1
3047-02-710	2,50 - 7,10 mm	M3 - M12	
3045-02-630	3,15 - 6,30 mm	M4 - M11	2
3042-02-900	3,55 - 9,00 mm	M6 - M14	3
3044-02-160	5,60 - 16,00 mm	M9 - M27	4
3046-02-180	6,00 - 18,00 mm	M10 - M30	
3048-02-315	14,00 - 31,50 mm	M24 - M52	5

Vratidlo na závitníky pro čtyřhran
Tap Holder
Pokrętła do gwintowników

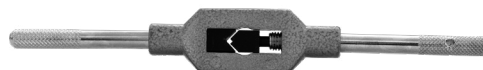

CODE	
3039-02-130	M1 - M8
3039-02-188	M3 - M10
3039-02-280	M4 - M12
3039-02-375	M5 - M20
3039-02-500	M9 - M27
3039-02-750	M13 - M52

Držák na závitová očka
Die Holder
Oprawka do narzynek



CODE		
3052	16 mm	M1 - M2,5
3053	20 mm	M3 - M6
3054	25 mm	M7 - M9
3055	30 mm	M10 - M11
3056	38 mm	M12 - M15

CODE		
3057	45 mm	M16 - M20
3058	55 mm	M22 - M26
3059	65 mm	M27 - M36
3059-1	75 mm	M39 - M42
3060	90 mm	M45 - M52

Nástavce závitníků | Tap Extensions | Przedłużacze gwintowników

Nástavce závitníků
Tap Extension
Przedłużacze gwintowników



CODE		↔
3049-06-315	3,15	90 mm
3049-06-355	3,55	95 mm
3049-06-400	4,00	100 mm
3049-06-500	5,00	110 mm
3049-06-560	5,60	115 mm
3049-06-620	6,20	125 mm
3049-06-630	6,30	120 mm
3049-06-710	7,10	125 mm
3049-06-900	9,00	135 mm

CODE		↔
3049-08-210	2,10	60 mm
3049-08-240	2,40	70 mm
3049-08-270	2,70	80 mm
3049-08-300	3,00	80 mm
3049-08-340	3,40	90 mm
3049-08-380	3,80	100 mm
3049-08-430	4,30	105 mm
3049-08-490	4,90	110 mm
3049-08-550	5,50	110 mm
3049-08-620	6,20	120 mm

CODE		↔
3049-08-800	8,00	125 mm
3049-08-100	10,00	140 mm
3049-08-110	11,00	150 mm
3049-08-120	12,00	155 mm
3049-08-130	13,00	165 mm
3049-08-145	14,50	175 mm
3049-08-160	16,00	180 mm
3049-08-180	18,00	200 mm
3049-08-200	20,00	200 mm
3049-08-220	22,00	220 mm

Úhelníky | Squares | Kątowniki

Úhelník přesný, plochý
Precision Flat Square
Kątownik precyzyjny płaski

DIN
875

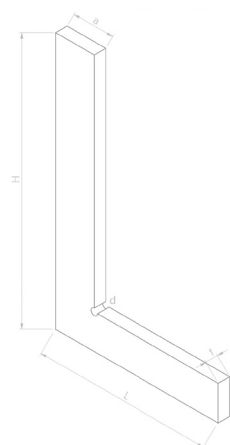

0
class

CODE	H [mm]	L [mm]	a [mm]	t [mm]
4033-02-007	75	50	17	6
4033-02-010	100	70	21	6
4033-02-015	150	100	26	8
4033-02-020	200	130	26	8
4033-02-025	250	160	31	8
4033-02-030	300	200	32	8
4033-02-040	400	250	40	8
4033-02-050	500	330	50	10
4033-02-060	600	400	50	10
4033-02-075	750	500	50	10
4033-02-100	1000	660	60	12

I
class

CODE	H [mm]	L [mm]	a [mm]	t [mm]
4033-12-007	75	50	17	6
4033-12-010	100	70	21	6
4033-12-015	150	100	26	8
4033-12-020	200	130	26	8
4033-12-025	250	160	31	8
4033-12-030	300	200	32	8
4033-12-040	400	250	40	8
4033-12-050	500	330	50	10
4033-12-060	600	400	50	10
4033-12-075	750	500	50	10
4033-12-100	1000	660	50	10

II
class

CODE	H [mm]	L [mm]	a [mm]	t [mm]
4033-22-007	75	50	17	6
4033-22-010	100	70	21	6
4033-22-015	150	100	26	8
4033-22-020	200	130	26	8
4033-22-025	250	160	31	8
4033-22-030	300	200	32	8
4033-22-040	400	250	40	8
4033-22-050	500	250	50	10
4033-22-060	600	300	50	10
4033-22-075	750	375	50	10
4033-22-100	1000	500	50	10
4033-22-150	1500	750	60	12
4033-22-200	2000	1000	60	12
4033-22-250	2500	1250	60	12

II
class

CODE	H [mm]	L [mm]	a [mm]	t [mm]
4027-03-060	600	330	50	6
4027-03-080	800	430	50	6
4027-03-100	1000	500	50	6
4027-03-150	1500	750	50	6

NEW

Úhelníky | Squares | Kątowniki

Úhelník přesný, příložný
Precision Try Square
Kątownik precyzyjny ze stopką

DIN
875

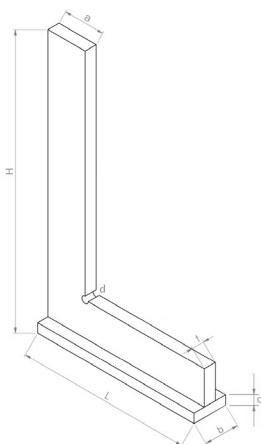

0
class

CODE	H [mm]	L [mm]	a [mm]	t [mm]	b [mm]	c [mm]
4034-02-007	75	50	17	6	16	6
4034-02-010	100	70	21	6	16	6
4034-02-015	150	100	26	8	20	8
4034-02-020	200	130	26	8	20	8
4034-02-025	250	160	31	8	25	8
4034-02-030	300	200	32	8	30	8
4034-02-040	400	250	40	8	30	8
4034-02-050	500	330	50	10	40	8
4034-02-060	600	400	50	10	40	8
4034-02-075	750	500	50	10	40	8
4034-02-100	1000	660	60	12	50	10

I
class

CODE	H [mm]	L [mm]	a [mm]	t [mm]	b [mm]	c [mm]
4034-12-007	75	50	17	6	16	6
4034-12-010	100	70	21	6	16	6
4034-12-015	150	100	26	8	20	8
4034-12-020	200	130	26	8	20	8
4034-12-025	250	160	31	8	25	8
4034-12-030	300	200	32	8	30	8
4034-12-040	400	250	40	8	30	8
4034-12-050	500	330	50	10	40	8
4034-12-060	600	400	50	10	40	8
4034-12-075	750	500	50	10	40	8
4034-12-100	1000	660	50	10	40	8

II
class

CODE	H [mm]	L [mm]	a [mm]	t [mm]	b [mm]	c [mm]
4034-22-007	75	50	17	6	16	6
4034-22-010	100	70	21	6	16	6
4034-22-015	150	100	26	8	20	6
4034-22-020	200	130	26	8	20	6
4034-22-025	250	160	31	8	25	8
4034-22-030	300	200	32	8	30	8
4034-22-040	400	250	40	8	30	8
4034-22-050	500	250	50	10	40	8
4034-22-060	600	300	50	10	40	8
4034-22-075	750	375	50	10	40	8
4034-22-100	1000	500	50	10	40	8
4034-22-150	1500	750	60	12	50	10
4034-22-200	2000	1000	60	12	50	10
4034-22-250	2500	1250	60	12	50	10

Úhelníky | Squares | Kątowniki

Úhelník přesný, plochý - NEREZ

Precision Flat Square - Stainless steel

Kątownik precyzyjny płaski - STAL NIERDZEWNIA

INOX

DIN
875

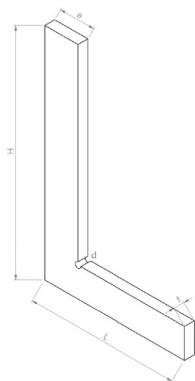

0
class

CODE	H [mm]	L [mm]	a [mm]	t [mm]
4033-07-007	75	50	17	6
4033-07-010	100	70	21	6
4033-07-015	150	100	26	8
4033-07-020	200	130	26	8
4033-07-025	250	165	31	8
4033-07-030	300	200	32	8
4033-07-040	400	265	40	8
4033-07-050	500	330	50	10

I
class

CODE	H [mm]	L [mm]	a [mm]	t [mm]
4033-17-007	75	50	17	6
4033-17-010	100	70	21	6
4033-17-015	150	100	26	8
4033-17-020	200	130	26	8
4033-17-025	250	165	31	8
4033-17-030	300	200	32	8
4033-17-040	400	265	40	8
4033-17-050	500	330	50	10

DALŠÍ ROZMĚRY NA ZAKÁZKU
OTHER SIZES ON REQUEST
INNE WYMIARY NA ZAMÓWIENIE

Úhelník přesný, příložný - NEREZ

Precision Try Square - Stainless steel

Kątownik precyzyjny ze stopką - STAL NIERDZEWNIA

INOX

DIN
875

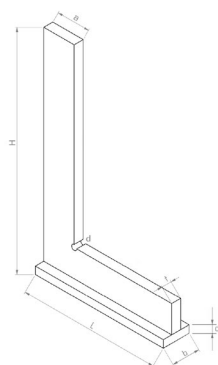

0
class

CODE	H [mm]	L [mm]	a [mm]	t [mm]	b [mm]	c [mm]
4034-07-007	75	50	17	6	12	5
4034-07-010	100	70	21	6	15	6
4034-07-015	150	100	26	8	20	6
4034-07-020	200	130	26	8	20	6
4034-07-025	250	165	31	8	25	8
4034-07-030	300	200	32	8	30	8
4034-07-040	400	265	40	8	30	8
4034-07-050	500	330	50	10	40	8

I
class

CODE	H [mm]	L [mm]	a [mm]	t [mm]	b [mm]	c [mm]
4034-17-007	75	50	17	6	12	5
4034-17-010	100	70	21	6	15	6
4034-17-015	150	100	26	8	20	6
4034-17-020	200	130	26	8	20	6
4034-17-025	250	165	31	8	25	8
4034-17-030	300	200	32	8	30	8
4034-17-040	400	265	40	8	30	8
4034-17-050	500	330	50	10	40	8

DALŠÍ ROZMĚRY NA ZAKÁZKU
OTHER SIZES ON REQUEST
INNE WYMIARY NA ZAMÓWIENIE

Úhelníky | Squares | Kątowniki

Úhelník příložený přesný - NOVÝ TYP

Precision Universal Square

Kątownik precyzyjny ze stopką - Nowy typ

DIN
875

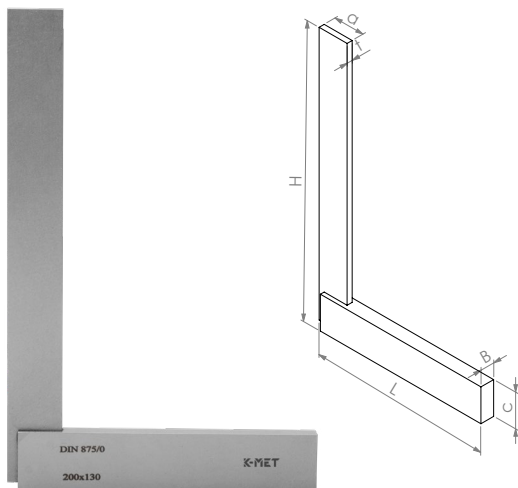

0
class

CODE	a [mm]	t [mm]	C [mm]	B [mm]	H [mm]	L [mm]
4026-02-006	16	4	16	10	60	40
4026-02-007	16	4	16	10	75	50
4026-02-010	16	4	20	10	100	70
4026-02-015	20	4	25	10	150	100
4026-02-020	22	4	25	10	200	130
4026-02-025	23	4	26	12	250	165
4026-02-030	24	4	27	12	300	200
4026-02-040	26	4	32	16	400	265
4026-02-050	30 - 32	4	32	16	500	330



4026-12-250

I
class

CODE	a [mm]	t [mm]	C [mm]	B [mm]	H [mm]	L [mm]
4026-12-006	16	4	16	10	60	40
4026-12-007	16	4	16	10	75	50
4026-12-010	16	4	20	10	100	70
4026-12-015	20	4	25	10	150	100
4026-12-020	22	4	25	10	200	130
4026-12-025	23	4	26	12	250	165
4026-12-030	24	4	27	12	300	200
4026-12-040	26	4	32	16	400	265
4026-12-050	30 - 32	4	32	16	500	330
4026-12-060	30 - 32	4	32	16	600	400
4026-12-153	sada set zestaw 60, 100, 150					
4026-12-154	sada set zestaw 60, 75, 100, 150					
4026-12-250	sada set zestaw 100, 150, 200, 250					

Ultralehký úhelník přesný, příložený K-MET ICONIC Labo (carbon/titan)

Ultralight Precise Square K-MET ICONIC Labo (carbon/titan)

Ultralekki kątownik K-MET ICONIC Labo (carbon/titan)

DIN
875



VHODNÝ PRO ROBOTICKÁ PRACoviŠTĚ
SUITABLE FOR ROBOTIC WORKPLACES
NADAJE SIĘ DO ZAUTOMATYZOWANEJ STACJI ROBOCZEJ

CODE	a [mm]	t [mm]	C [mm]	B [mm]	H [mm]	L [mm]
4026-28-006	12x1,5	1,5	12	10	60	40



Úhelníky | Squares | Kątowniki

Úhelník přesný plochý typ "Au"
Precision Flat Square "Au"
Kątownik precyzyjny płaski typ "Au"

ČSN
25 5103

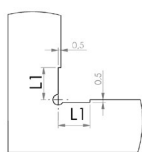
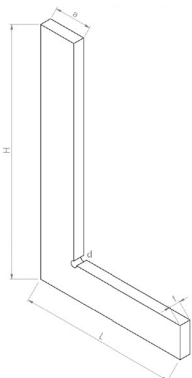

ČSN
I

CODE	H [mm]	L [mm]	a [mm]	t [mm]	L1 [mm]
4034	63	40	17	6	-
4035	100	63	21	6	-
4036	160	100	26	8	-
4037	250	160	31	8	-
4038	400	250	40	8	18
4039	630	400	50	12	22

Úhelník přesný plochý kalený typ "A"
Precision Flat Square Hardened "A"
Kątownik precyzyjny płaski hartowany typu "A"

ČSN
25 5103

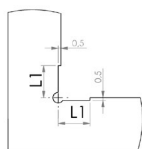
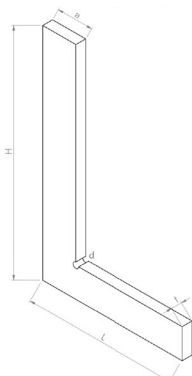

ČSN
I

CODE	H [mm]	L [mm]	a [mm]	t [mm]	L1 [mm]
4045	63	40	17	6	-
4046	100	63	21	6	-
4047	160	100	26	8	-
4048	250	160	31	8	-
4049	400	250	40	8	18

Úhelník přesný příložný typ "Bu"
Precision Try Square "Bu"
Kątownik precyzyjny ze stopką typu "Bu"

ČSN
25 5103

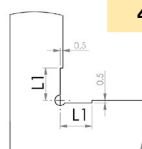
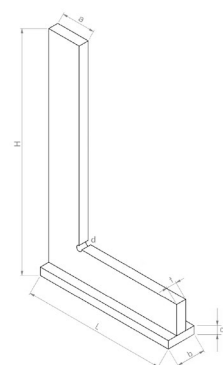

ČSN
II

CODE	H [mm]	L [mm]	a [mm]	t [mm]	b [mm]	c [mm]	L1 [mm]
4051	63	40	17	6	12	6	-
4052	100	63	21	6	15	6	-
4053	160	100	26	8	20	6	-
4054	250	160	31	8	25	8	-
4055	400	250	40	8	30	8	18
4056	630	400	50	12	40	8	22

Úhelníky | Squares | Kątowniki

Úhelník přesný příložený kalený typ "B"

Precision Try Square Hardened "B"

Kątownik precyzyjny ze stopką hartowany typu "B"

ČSN
25 5103

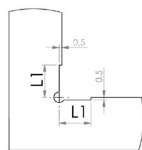
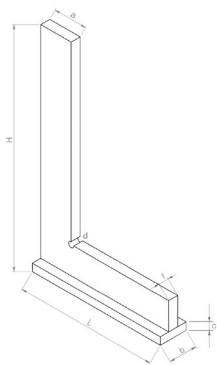

ČSN
II

CODE	H [mm]	L [mm]	a [mm]	t [mm]	b [mm]	c [mm]	L1 [mm]
4058	63	40	17	6	12	6	-
4059	100	63	21	6	15	6	-
4060	160	100	26	8	20	6	-
4061	250	160	31	8	25	8	-
4061-1	400	250	40	8	25	8	18

Úhelník zámečnický plochý

Flat Square

Kątownik płaski

PN
25 5120

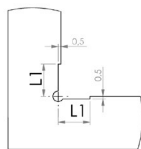
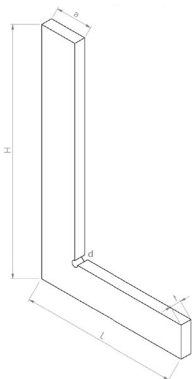

CODE	H [mm]	L [mm]	a [mm]	t [mm]	L1 [mm]
4010	100	63	17	4	-
4011	160	100	26	5	-
4012	250	160	26	5	-
4013	400	250	32	6	18
4014	630	400	40	8	22
4015	750	375	40	8	22
4016	1000	500	40	8	22

Úhelník zámečnický příložený

Try Square

Kątownik ze stopką

PN
25 5124

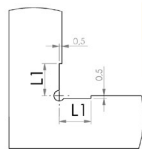
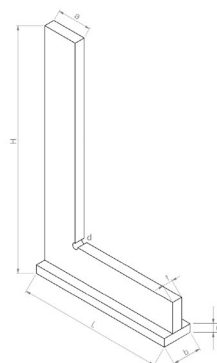

CODE	H [mm]	L [mm]	a [mm]	t [mm]	b [mm]	c [mm]	L1 [mm]
4020	100	63	17	4	16	4	-
4021	160	100	26	5	25	5	-
4022	250	160	26	5	25	5	-
4023	400	250	32	6	32	6	18
4024	630	400	40	8	40	8	22
4025	750	375	40	8	40	8	22
4025-1	1000	500	40	8	40	8	22

Úhelníky | Squares | Kątowniki

Úhelník s pružným ramenem a mm dělením
Flexible Precision Square with mm graduation
Kątownik z elastycznym ramieniem i mm skalą

ČSN
25 5133

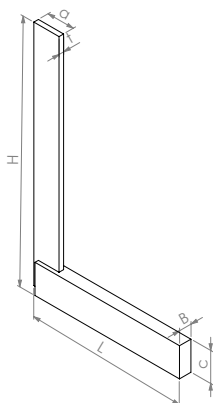
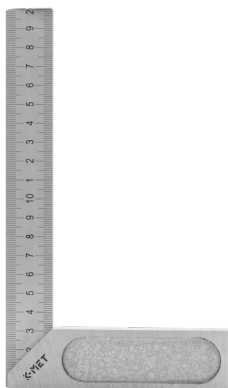

CODE	a [mm]	t [mm]	c [mm]	B [mm]	↔
4031	30	1	15	5	200x120 mm
4032	30	1	15	5	250x150 mm

Úhelník BLACK COAT s mm dělením
Square BLACK COAT with mm graduation
Kątownik BLACK COAT - skala mm

Al

STEEL

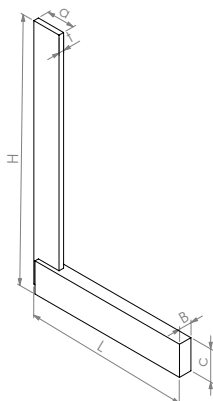
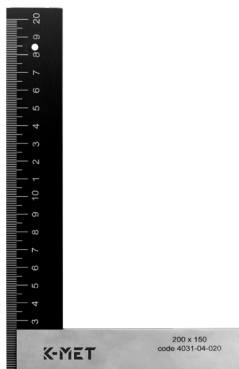

hliník/ocel | hliník/ocel' | aluminium/stal

CODE	a [mm]	t [mm]	c [mm]	B [mm]	↔
4031-03-020	32	5	25	10	200x130 mm
4031-03-025	32	5	26	12	250x165 mm
4031-03-030	32	5	27	12	300x200 mm

Úhelník s mm dělením
Square with mm graduation
Kątownik - skala mm

ČSN
25 5103

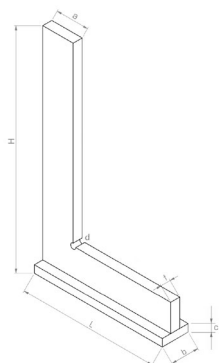
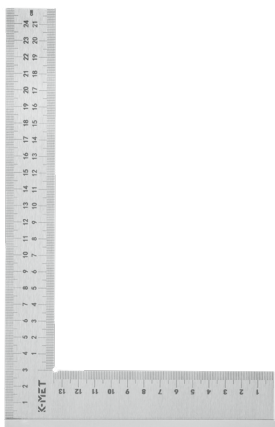

ČSN
II

CODE	H [mm]	L [mm]	a [mm]	t [mm]	b [mm]	c [mm]
4054-122-250	250	160	31	8	25	8

Úhelníky | Squares | Kątowniki

Úhelník nožový - přesný kalený, typ E
Precision Knife Edge Square "E"
Kątownik krawędziowy - prec. hartowany, typ E

00
class
ČSN
25 5103

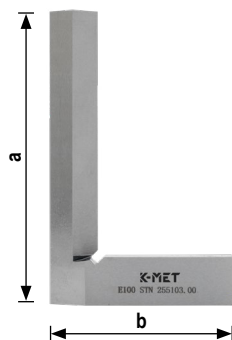

CODE		a [mm]	b [mm]
4001	7x11 / 11x11 mm	63	35
4002	11x17 / 14x17 mm	100	63
4003	12x20 / 20x20 mm	160	100
4004	12x20 / 20x20 mm	200	130

Úhelník nožový - přesný kalený, typ C
Precision Knife Edge Square "C"
Kątownik krawędziowy - prec., hartowany, typ C

00
class
DIN
875

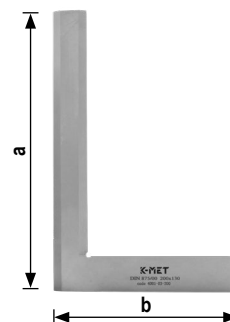

CODE		a [mm]	b [mm]
4001-03-063	5,5x16 mm	63	40
4001-03-075	5,5x16 mm	75	50
4001-03-100	5,5x20 mm	100	70
4001-03-150	7,7x25 mm	150	100
4001-03-200	7,7x25 mm	200	130
4001-03-250	7,7x30 mm	250	160

Úhelník svařovaný příložný dílenský - úprava pozink
Workshop Flat Square
Kątownik ślusarski ze stopką galwanizowany



CODE	H [mm]	L [mm]	a [mm]	t [mm]
4020-30	100	70	20	5
4020-31	150	100	20	5
4020-32	200	130	20	5
4020-33	250	160	25	5
4020-34	300	180	25	5
4020-35	400	230	30	5
4020-36	500	280	30	5
4020-37	600	330	30	5
4020-38	750	375	30	5

Toto provedení úhelníků není určeno ke kalibraci.
Not intended for calibration.
Kątownik nie jest przeznaczony do kalibracji.

Úhelník tesařský
Carpenter Square
Kątownik stolarski



CODE		
4028	30x1 / 32x5 mm	400x230 mm
4029	30x1 / 32x5 mm	750x375 mm
4030	30x1 / 32x5 mm	1000x375 mm

Úhelník tesařský s mm dělením
Flexible Square with mm graduation
Kątownik stolarski ze skalą

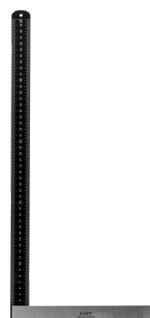

CODE		
4028-1	30x1 / 32x6 mm	500x230 mm
4029-1	30x1 / 32x6 mm	750x375 mm
4030-1	30x1 / 32x6 mm	1000x375 mm

Úhelníky | Squares | Kątowniki

Úhelník plochý 45°
Precision Flat Square 45°
Kątownik płaski 45°

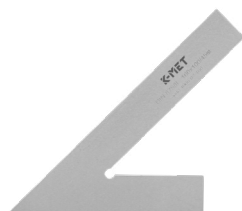

CODE		
4006-02-120	20x5 mm	120x 80 mm
4006-02-160	20x5 mm	160x100 mm
4006-02-200	25x5 mm	200x130 mm

Úhelník příložný 45°
Precision Try Square 45°
Kątownik ze stopką 45°



CODE		
4007-02-120	20x5 mm	120x 80 mm
4007-02-160	20x5 mm	160x100 mm
4007-02-200	25x5 mm	200x130 mm

Vyrábíme a dodáváme úhelníky s různými úhly (60°, 120°, 135°)
We manufacture and supply squares with different angles (60°, 120°, 135°)
Produkujemy i dostarczamy kątowniki z różnymi kątami (60°, 120°, 135°)

Trojúhelník
Triangle
Trójkąt



CODE		
4080	45°	250 mm
4085	60°	250 mm

Úhelník středící
Centre Square
Kątownik centrujący

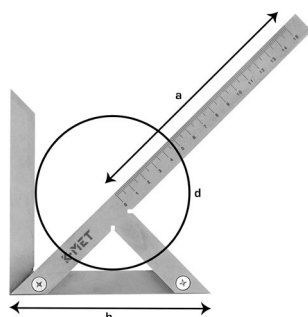

CODE	a [mm]	d [mm]	h [mm]
4062	100	70	90
4062-1	150	130	180
4062-2	200	150	210
4062-3	300	180	250
4062-4	400	250	250
4062-5	500	330	250

Úhelník přírubový, síla 30x5mm
Flange Square
Kątownik do ustawiania kołnierzy 30x5mm

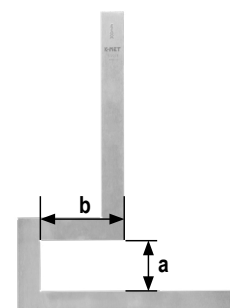

CODE		a [mm]	b [mm]
4063-10	300x300 mm	65	105
4063-11	400x400 mm	65	115
4063-12	500x500 mm	70	125
4063-13	600x600 mm	70	125
4063-14	800x800 mm	95	135

Vodováhy | Spirit levels | Poziomice

Vodováha digitální
Inclinometer
Poziomica elektroniczna



5017-02-050



5017-05-150



5017-97-150

CODE	Resolution	Features
5017-02-050	0,1°	bez libely without vial bez fiolek
5017-05-150	0,01°	
5017-97-150	0,01°	s bluetooth with bluetooth z bluetooth

Vodováha digitální zednická
Digital Level with Laser
Poziomica elektroniczna



CODE	Resolution	Vials	Features
5017-02-600	0,1°	2 libely 2 fioleki	s laserem (30m) with laser (30m) z laserem (30m)

Vodováha zednická s magnetem
Spirit Level with Magnets and 3 Vials
Poziomica z magnešem i 3 ampułkami



CODE	Resolution	Length
5018-0	0,5 mm/1 m	400 mm
5018-1	0,5 mm/1 m	600 mm
5018-2	0,5 mm/1 m	800 mm
5018-3	0,5 mm/1 m	1000 mm
5018-4	0,5 mm/1 m	1200 mm
5018-5	0,5 mm/1 m	1500 mm
5018-6	0,5 mm/1 m	2000 mm

Vodováha hadicová
Hose Level
Poziomica węzowa (para - szkło)



5035-3



5036

CODE	Resolution	Material	Length
5036	pár pair para	plast plastic plastikowy	
5035-3	sada set zestaw		10 m
5035-4	sada set zestaw		15 m

Vodováha k ustavení sloupků s magnetem - plast
Hose Level
Poziomica plastikowa z magnešem



CODE
5036-5

Olovnice
Plumb
Poziomica pionowa



5036-02-008



5036-08-006

CODE	Length
5036-02-008	8 m
5036-08-006	6 m

Vodováhy | Spirit levels | Poziomice

Vodováha přesná strojní NEW MODEL
High Precision Spirit Level NEW MODEL
Poziomica liniarowa NEW MODEL

PN
25 5727-1



CODE		↔
5050-02-150	0,02 mm	150x42x40 mm
5050-02-200	0,02 mm	200x42x40 mm
5050-02-250	0,02 mm	250x42x40 mm
5050-02-300	0,02 mm	300x42x40 mm
5050-02-400	0,02 mm	400x42x40 mm
5050-02-500	0,02 mm	500x42x40 mm

Vodováha přesná strojní s magnetickým upínáním NEW MODEL
High-precision Longitude Spirit Level, Magnetic clamping NEW MODEL
Poziomica liniarowa z mocowaniem magnetycznym NEW MODEL

 **PN**
25 5727-1

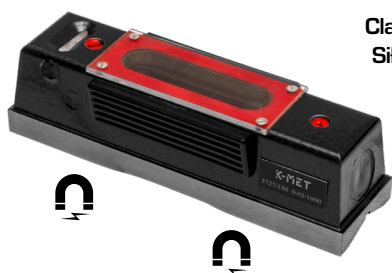

Upínací síla 60 N (6 kg)
Clamping force 60 N (6 kg)
Siła zaciskania 60 N (6 kg)

CODE		↔
5051-02-150	0,02 mm	150x42x40 mm
5051-02-200	0,02 mm	200x42x40 mm
5051-02-250	0,02 mm	250x42x40 mm
5051-02-300	0,02 mm	300x42x40 mm

Vodováha přesná strojní
Precision Cross Short Level
Poziomica liniarowa

PN
25 5726-1



CODE		↔
5110-02-100	0,2 mm	100x40x32 mm
5110-02-150	0,2 mm	150x40x32 mm

Vodováha přesná strojní
Precision Longitude Spirit Level
Poziomica liniarowa

PN
25 5721-1



CODE		↔
5115-02-150	0,2 mm	150x42x40 mm
5115-02-200	0,2 mm	200x42x40 mm
5115-02-250	0,2 mm	250x42x40 mm
5115-02-300	0,2 mm	300x42x40 mm
5115-02-400	0,2 mm	400x42x40 mm

Vodováhy | Spirit levels | Poziomice

Vodováha přesná strojní
High-precision Spirit Level
Poziomnica ramowa

PN
25 5739-1



Vodováha přesná strojní s magn. upínáním
High-precision Longitude Spirit Level Magnetic
Poziomnica ramowa z mocowaniem magnetycznym



PN
25 5739-1



Upínací síla 60 N (6 kg)
Clamping force 60 N (6 kg)
Siła zaciskania 60 N (6 kg)

CODE		
5090-02-150	0,02 mm	150x150x44 mm
5090-02-200	0,02 mm	200x200x44 mm
5090-02-250	0,02 mm	250x250x44 mm
5090-02-300	0,02 mm	300x300x44 mm

CODE		
5091-02-150	0,02 mm	150x150x44 mm
5091-02-200	0,02 mm	200x200x44 mm
5091-02-250	0,02 mm	250x250x44 mm
5091-02-300	0,02 mm	300x300x44 mm

Vodováha přesná strojní
High-precision Spirit Level
Poziomnica ramowa

PN
25 5737-1



5080-02-100



5080-02-150
5080-02-200
5080-02-250
5080-02-300

CODE		
5080-02-100	0,2 mm	100x100x25 mm
5080-02-150	0,2 mm	150x150x43 mm
5080-02-200	0,2 mm	200x200x43 mm
5080-02-250	0,2 mm	250x250x43 mm
5080-02-300	0,2 mm	300x300x43 mm

Vodováhy | Vodováhy | Poziomice centrująca

Kruhov libela - plast
Circular Vial - plastic
Poziomica centrująca – plastikowa

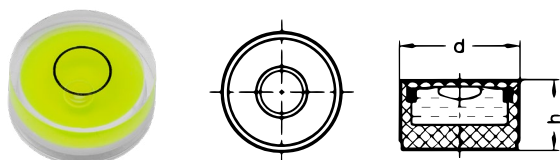

CODE	d [mm]	h [mm]
5022-01-025	25	10,5

Kruhov libela s upevovacmi otvory - plast
Circular Vial with mounting holes - plastic
Plastikowa poziomica centrująca z otworami montażowymi

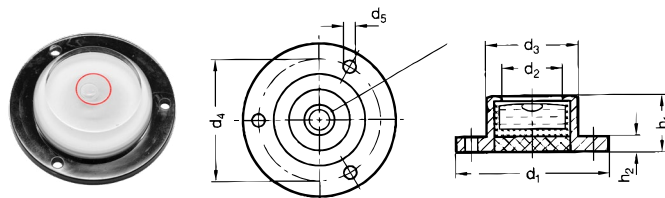

CODE	d1	d2	d3	d4	d5	h1	h2
5022-02-030	40	24	30	36	3,5	11	2,5

Kruhov libela s upevovacmi otvory stbrn - hlink
Circular Vial with Mounting Holes - anodized silver
Aluminiowa poziomica centrująca z otworami montażowymi - srebrna

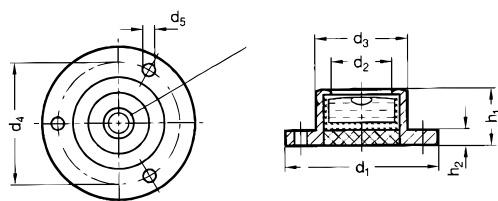
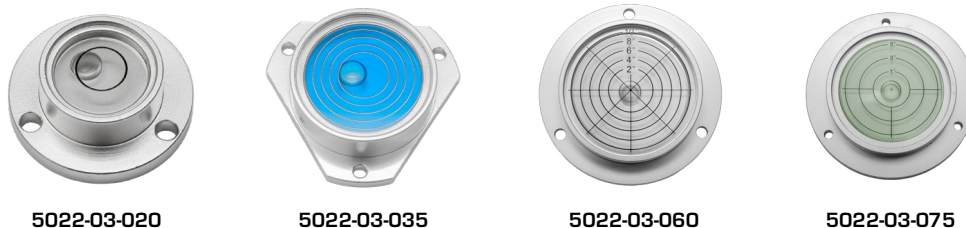

CODE		d1	d2	d3	d4	d5	h1	h2
5022-03-020	5' - 60' / 2 mm	30	16	20	25	3,5	11	3,5
5022-03-035	5' - 60' / 2 mm	-	28	35	46	3,5	13	3,5
5022-03-060	± 10°	80	57	62	70	5,0	15	5,0
5022-03-075	± 5°	100	60	75	85	5,0	20	8,0

Kruhov libela s upevovacmi otvory ern - hlink
Circular Vial with Mounting Holes - anodized black
Aluminiowa poziomica centrująca z otworami montażowymi – czarna

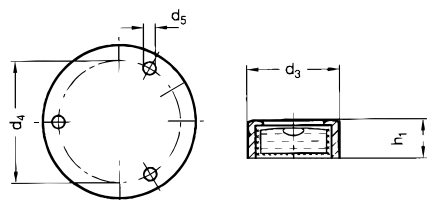

CODE		d1	d2	d3	d4	d5	h1	h2
5022-04-035	30' / 2 mm (9 mm/m)	80	28	35	70	5,0	18	9
5022-04-080		-	-	80	66	5,5	18	-

Libela plastov
Plastic Vial
Fiolka plastikowa

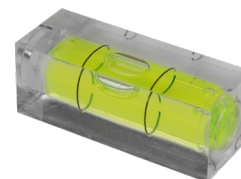

CODE		
5022-1	plast plastic	40x15x15 mm

Posuvná měřítka | Calipers | Suwmiarki

Posuvné měřítko s hloubkoměrem a vnitřním měřením, aretace šroubkem

Vernier Caliper with Locking Screw and Depth Gauge

Suwmiarka analogowa z pomiarem głębokości i pomiarem wewnętrznym ze śrubą zabezpieczającą

DIN
862

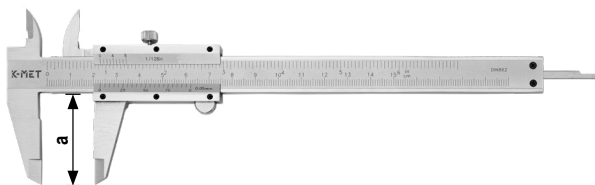

CODE			a [mm]	
6000	0,02 mm	150 mm	40	šroub. skrutkov. śruba nonius
6000-1	0,05 mm+inch	150 mm	40	šroub. skrutkov. śruba nonius
6000-2	0,02 mm+inch	150 mm	40	monoblok, INOX
6000-25	0,02 mm+inch	160 mm	40	monoblok, INOX
6000-26	0,05 mm+inch	160 mm	40	monoblok, INOX
6000-7	0,05 mm	70 mm	30	monoblok, INOX

Posuvné měřítko s hloubkoměrem a vnitřním měřením, aretace tlačítkem

Vernier Caliper with Thumb Lock and Depth Gauge

Suwmiarka analogowa z pomiarem głębokości i pomiarem wewnętrznym z przyciskiem blokującym

DIN
862

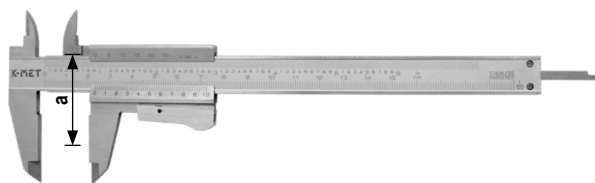

CODE			a [mm]	
6000-3	0,02 mm+inch	150 mm	40	monoblok, INOX
6000-4	0,05 mm+inch	150 mm	40	monoblok, INOX
6000-20	0,02 mm+inch	160 mm	40	monoblok, INOX
6000-21	0,05 mm+inch	160 mm	40	monoblok, INOX

Posuvné měřítko s hloubkoměrem a vnitřním měřením, paralelní vedení, aretace šroubkem, TOP QUALITY

Vernier Caliper with Locking Screw and Depth Gauge, parallax, TOP QUALITY

Suwmiarka analogowa z pomiarem głębokości i pomiarem wewnętrznym, pararelne prowadzenie, śruby aretujące - TOP QUALITY

DIN
862

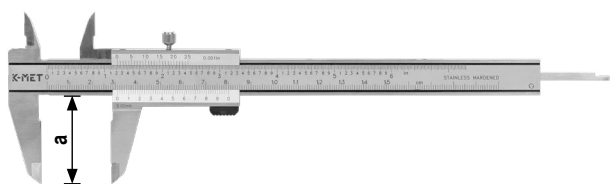

CODE			a [mm]	
6000-02-150	0,02 mm+inch	150 mm	40	monoblok
6000-02-200	0,02 mm+inch	200 mm	50	monoblok
6000-02-300	0,02 mm+inch	300 mm	60	monoblok

Posuvné měřítko PRO LEVÁKY s hloubkoměrem a vnitřním měřením, jemné stavění, paralelní vedení, aretace šroub., TOP QUALITY

Vernier Caliper FOR LEFT-HANDERS with Locking Screw and Depth Gauge, paralex line type, TOP QUALITY

Suwmiarka DLA LEWORĘCZNYCH analogowa z pomiarem głębokości i pomiarem wewnętrznym, pararelne prowadzenie, śruby aret. - TOP QUALITY

DIN
862

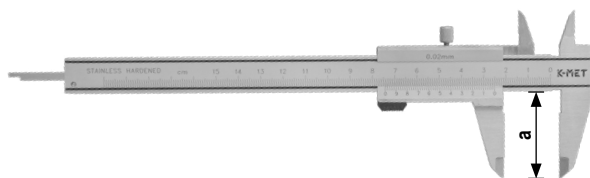

CODE			a [mm]	
6000-12-150	0,02 mm	150 mm	40	monoblok

Posuvná měřítka | Calipers | Suwmiarki

Posuvné měřítko s vnitřním měřením, jemné stavění
 Vernier Caliper with Locking Screw and Depth Gauge, Fine Adjustment
 Suwmiarka ze šrubą i suwakiem pomocniczym

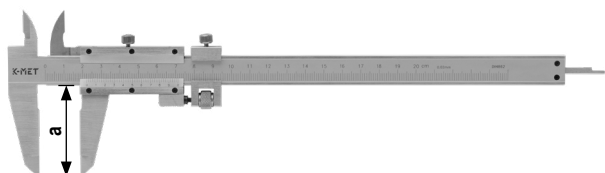

CODE			a [mm]	
6002	0,02 mm	200 mm	50	šroub. screw śruba non.
6003	0,02 mm	300 mm	55	šroub. screw śruba non.

Posuvné měřítko s vnitřním měřením a hloubkoměrem, jemné stavění
 Vernier Caliper with Locking Screw and Depth Gauge, Fine Adjustment
 Suwmiarka ze šrubą i suwakiem pomocniczym, precyzyjna regulacja

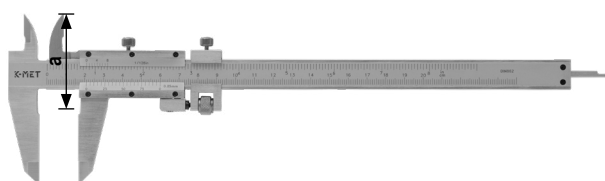

CODE			a [mm]	
6002-90-1	0,05 mm + 1/128 inch	200 mm	50	šroub. screw śruba non.
6003-90-1	0,05 mm + 1/128 inch	300 mm	55	šroub. screw śruba non.

Posuvné měřítko s číselníkovým úchylkoměrem ANTISHOCK (nárazuvzdorné provedení)
 Dial Caliper and Depth Gauge ANTISHOCK
 Suwmiarka z czujnikiem zegarowym ANTISHOCK (wstrząsoodporny projekt)



CODE			a [mm]
6013-02-150	0,02 mm	150 mm	40
6013-02-200	0,02 mm	200 mm	45
6013-02-300	0,02 mm	300 mm	55

Posuvné měřítko na frézy - 3/5 bodové
 3 Flutes and 5 Flutes Vernier Caliper
 Suwmiarka do przecinarek - 3/5 punktu

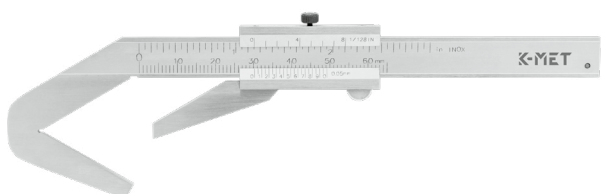

CODE			a [mm]
6004-02-043	0,05 mm	4 - 40 mm	3
6004-02-045	0,05 mm	1 - 40 mm	5

Posuvná měřítka na rýsování | Marking Calipers | Suwmiarki do rysowania

Posuvné měřítka na rýsování
Marking Caliper
Suwmiarka traserska z rysikiem

0,02



CODE		a [mm]
6005-10	150 mm	40
6005-15	200 mm	40
6005-20	250 mm	40
6005-25	300 mm	40

Posuvné měřítka rýsovací s výměnným hrotem, šroubovací nonius
Marking Caliper with Replaceable Tip & Screw Vernier
Suwmiarka traserska z rysikiem, grottem węglkowym, śrubą noniusza

0,02



CODE	hrot tip końcówka	
6005-50	29x2 mm	200/40 mm
6005-55	29x2 mm	400/40 mm
6006-2	náhr. hrot - tvrdokov repl. tip - carbide zapasowa końcówka utwardzana	

Přípravek na orýsování s mm stupnicí NEREZOVÁ OCEL
Steel Marking Gauge STAINLESS STEEL
Przymiar kreskowy nastawny STAL NIERDZEWNA

INOX

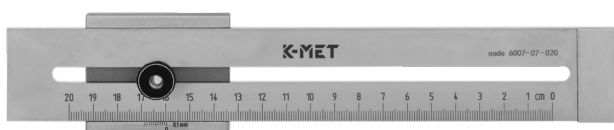

CODE	
6007-07-015	150 mm
6007-07-020	200 mm
6007-07-030	300 mm

Posuvné měřítka na rýsování paralelní typ T
Steel Marking Gauge type T
Suwmiarka traserska równoległa typu T

0,05

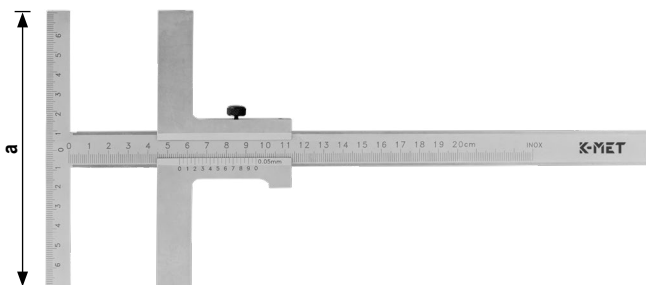

CODE		a [mm]
6007-02-160	160 mm	120
6007-02-250	250 mm	140
6007-02-300	300 mm	160
6007-02-400	400 mm	160
6007-02-500	500 mm	160

Posuvná měřítka | Calipers | Suwmiarki

Posuvné měřítka s jemným stavěním, šroubovací nonius
 Vernier Caliper with Locking Screw and Fine Adjustment, vernier screw
 Suwmiarka jednostronna z suwakiem pomocniczym, śruba noniusza

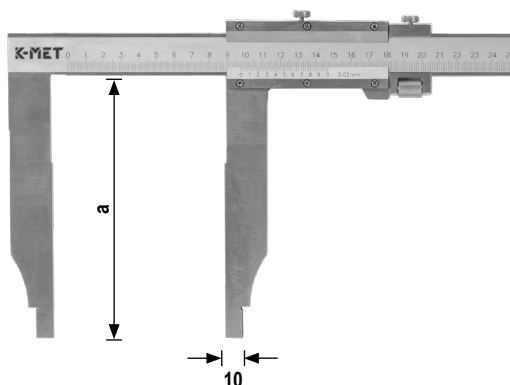

Od 500 mm dodáváno včetně protokolu o přeměření.
 From 500 mm supplied with the Measuring Protocol.
 Od 500 mm dostarczamy wraz z protokołem o przemierzeniu.

CODE			a [mm]
6015-62-100	0,02 mm	400 mm	100
6015-02-100	0,02 mm	500 mm	100
6015-02-125	0,02 mm	500 mm	125
6015-02-150	0,02 mm	500 mm	150
6015-02-200	0,02 mm	500 mm	200
6015-12-100	0,02 mm	600 mm	100
6015-12-125	0,02 mm	600 mm	125
6015-12-150	0,02 mm	600 mm	150
6015-12-200	0,05 mm	600 mm	200
6015-12-300	0,05 mm	600 mm	300
6015-22-150	0,02 mm	800 mm	150
6015-22-200	0,02 mm	800 mm	200
6015-22-300	0,05 mm	800 mm	300
6015-32-125	0,02 mm	1000 mm	125
6015-32-150	0,02 mm	1000 mm	150
6015-32-200	0,02 mm	1000 mm	200
6015-42-150	0,02 mm	1500 mm	150
6015-42-200	0,02 mm	1500 mm	200
6015-52-200	0,05 mm	2000 mm	200
6015-52-300	0,05 mm	2000 mm	300
6015-72-200	0,05 mm	2500 mm	200
6015-72-300	0,05 mm	2500 mm	300

Posuvná měřítka | Calipers | Suwmiarki

Posuvné měřítko s jemným stavěním a stupnicí mm + inch
 Vernier Caliper with Locking Screw and Fine Adjustment, mm + inch
 Suwmiarka jednostronna z suwakiem pomocniczym i skalą mm + inch

ČSN
EN ISO
13385-1

ČSN
25 1231

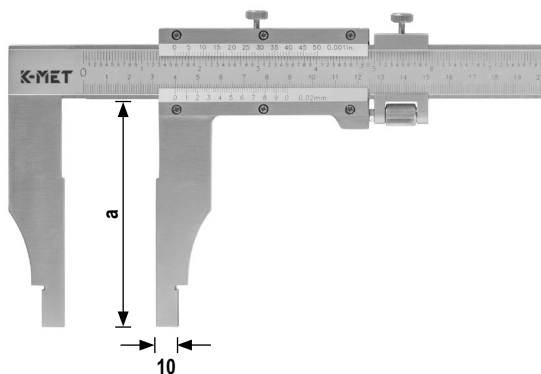

CODE			a [mm]
6015-08-040	0,05 mm + 1/128 inch	400 mm	100
6015-08-050	0,05 mm + 1/128 inch	500 mm	125
6015-08-060	0,05 mm + 1/128 inch	600 mm	125
6015-08-100	0,05 mm + 1/128 inch	1000 mm	125
6015-08-150	0,05 mm + 1/128 inch	1500 mm	125
6015-08-200	0,05 mm + 1/128 inch	2000 mm	125

Posuvné měřítko s horními čelistmi s jemným stavěním, šroubovací nonius
 Vernier Caliper with Locking Screw and Fine Adjustment with upper jaws
 Suwmiarka z suwakiem pomocniczym z górnymi szczękami, śruba noniusza

ČSN
EN ISO
13385-1

ČSN
25 1234

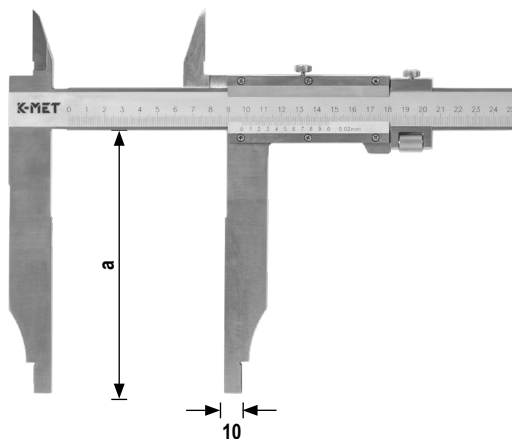

CODE			a [mm]
6022-62-100	0,02 mm	400 mm	150
6022-02-150	0,02 mm	500 mm	150
6022-12-150	0,02 mm	600 mm	150
6022-22-150	0,02 mm	800 mm	150
6022-32-150	0,02 mm	1000 mm	150
6022-42-200	0,02 mm	1500 mm	200
6022-52-150	0,02 mm	2000 mm	150
6022-52-200	0,05 mm	2000 mm	200

Od 500 mm dodáváno včetně protokolu o přeměření.
 From 500 mm supplied with the Measuring Protocol.
 Od 500 mm dostarczamy wraz z protokołem o przemierzeniu.

Posuvná měřítka | Calipers | Suwmiarki

Digitální posuvné měřítko K-MET Labo ICONIC do vlhkého prostředí, Bluetooth
 Digital Caliper K-MET ICONIC Labo - moisture resistant IP 67, TOP QUALITY, Bluetooth
 Suwmiarka elektroniczna K-MET Labo ICONIC do środowiska wilgotnego, Bluetooth

INOX

0,01



DIN
862



Dodáváno včetně protokolu o přeměření,
 Supplied with the Measuring Protocol.
 Dostarczamy wraz z protokołem o przemierzeniu.



BLUETOOTH PROFILE

Integrovaný bezdrátový přenos dat přes Bluetooth
 pro základní použití se k připojení jako zařízení standardu HID,
 není potřeba žádný další software

Integrated wireless data transfer via Bluetooth
 for basic use, connect as HID standard device,
 no additional software is needed.

Zintegrowany bezprzewodowy transfer danych poprzez Bluetooth.
 Do codziennego użytkowania. Podłącz jako urządzenie standardowe HID,
 żadne dodatkowe oprogramowanie nie jest potrzebne.

- » Ochrana IP67
- » Induktivní měřicí systém
- » Automatické zapnutí pohybem DIGI jednotky
- » Automatické vypnutí při nečinnosti měřidla
- » Paměť poslední měřené hodnoty
- » Maximální rychlost pohybu 3,2 m/s
- » **Lapované** měřicí plochy čelistí
- » Přesnost dle **DIN 862**
- » Velkoformátový displej
- » **Integrovaný Bluetooth modul**
- » API pro připojení softwarových aplikací

- » IP67 protection
- » Inductive measuring system
- » Automatic switching on by moving the DIGI unit
- » Automatic sleep when idle
- » Memory of the last measured value
- » Maximum movement speed 3.2 m/s
- » **Lapped** measuring surfaces of the jaws
- » Accuracy according to **DIN 862**
- » Large format display
- » **Integrated Bluetooth module**
- » API for connecting software applications

- » Stopień ochrony IP67
- » Indukcyjny system pomiarowy
- » Automatyczne włączanie poprzez przesunięcie jednostki DIGI
- » Automatyczne wyłączenie, gdy jest nieaktywne
- » Pamięć ostatniej zmierzonej wartości
- » Maksymalna prędkość ruchu 3.2 m/s
- » **Docierane** powierzchnie pomiarowe szczęk
- » Dokładność zgodnie z **DIN 862**
- » Wyświetlacz wielkoformatowy
- » **Zintegrowany moduł Bluetooth**
- » API do łączenia aplikacji programowych

CODE		L	a	b	c	d
6041-97-150	0 - 150 mm	235	40	19,5	15	16
6041-97-200	0 - 200 mm	287	49	24	20	16
6041-97-300	0 - 300 mm	392	59	26	23	16

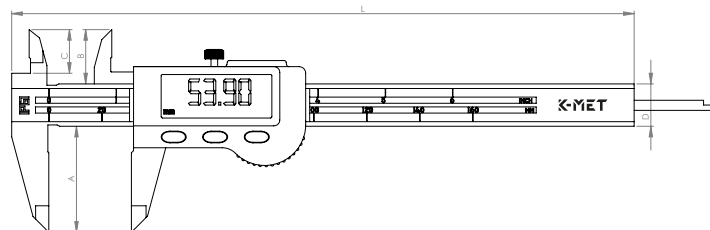

Posuvná měřítka | Calipers | Suwmiarki

Digitální posuvné měřítko K-MET ABSOLUTE ZERO
 Digital Caliper K-MET ABSOLUTE ZERO
 Suwmiarka elektroniczna K-MET ABSOLUTE ZERO

0,01

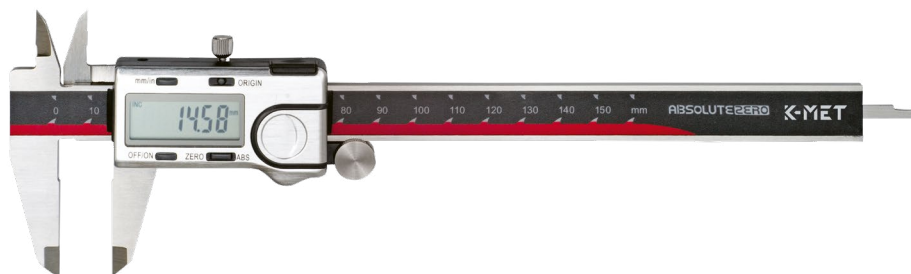

automatické vypínání při nečinnosti
 automatic sleep when idle
 automatycznie wyłączenie w stanie beczynności

Dodáváno včetně protokolu o přeměření.
 Supplied with the Measuring Protocol.
 Dostarczamy wraz z protokołem o przemierzeniu.

CODE	— —	L [mm]	a [mm]	b [mm]	c [mm]	d [mm]
6040-05-100	0 - 100 mm	184,5	40	11	16	16x3,5
6040-05-150	0 - 150 mm	234,5	40	11	16	16x3,5
6040-05-151 *	0 - 150 mm	234,5	40	11	16	16x3,5
6040-05-200	0 - 200 mm	290,5	50	14	19	16x3,5
6040-05-300	0 - 300 mm	388,0	64	14	19	16x4,0

* kulatý hloubkoměr | round depth | okrągłe głębia \varnothing 1,5mm

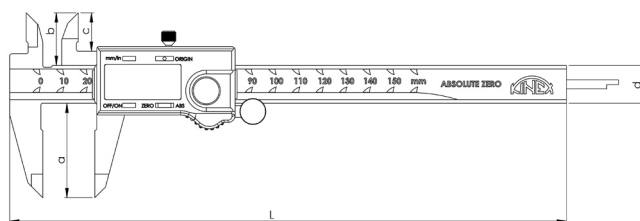

Digitální posuvné měřítko
 Digital Caliper
 Suwmiarka elektroniczna



0,01

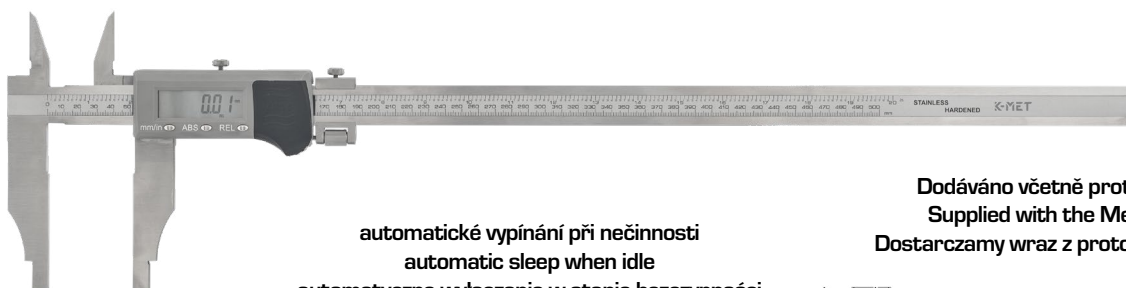

automatické vypínání při nečinnosti
 automatic sleep when idle
 automatycznie wyłączenie w stanie beczynności

Dodáváno včetně protokolu o přeměření.
 Supplied with the Measuring Protocol.
 Dostarczamy wraz z protokołem o przemierzeniu.

CODE	— —	a [mm]	b [mm]	c [mm]	d [mm]	IP66
6040-25-500	0,01 mm 0 - 500 mm	100	45	39	24	IP66

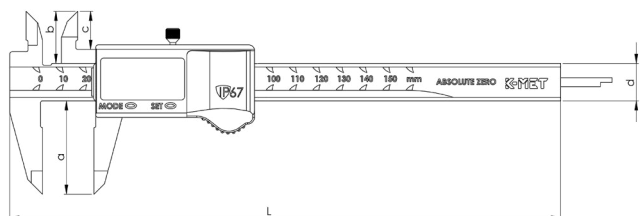

Posuvná měřítka | Calipers | Suwmiarki

Posuvné měřítko digitální - tvrdokov
 Digital Caliper - carbide
 Suwmiarka elektroniczna - węgiel



0,01

DIN
862



tvrdokov | carbide | węgiel

CODE			a [mm]
6041-25-150	0,01 mm	0 - 150 mm	40 mm

automatické vypínání při nečinnosti
 automatic sleep when idle
 automatyczne wyłączenie w stanie bezczynności

Posuvné měřítko digitální
 Digital Caliper
 Suwmiarka elektroniczna

0,01

DIN
862

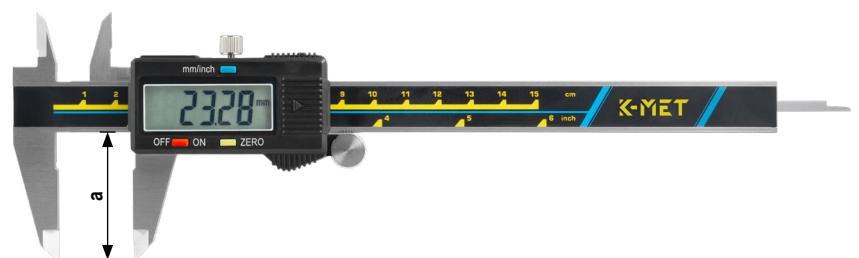

CODE			a [mm]
6040-2	0,01 mm	0 - 150 mm	40 mm
6041-2	0,01 mm	0 - 200 mm	50 mm
6042-2	0,01 mm	0 - 300 mm	60 mm

Posuvné měřítko digitální
 Digital Caliper
 Suwmiarka elektroniczna

0,01

DIN
862

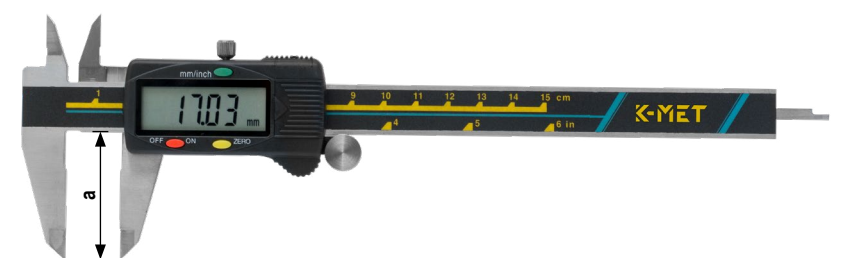

CODE			a [mm]
6040-02-150	0,01 mm	0 - 150 mm	40 mm
6040-02-200	0,01 mm	0 - 200 mm	50 mm
6040-02-300	0,01 mm	0 - 300 mm	60 mm

Posuvné měřítko digitální - pro leváky
 Digital Caliper for left-handers
 Suwmiarka elektroniczna - dla leworęcznych

0,01

DIN
862



CODE			a [mm]
6040-14-150	0,01 mm	150 mm	40 mm
6040-14-200	0,01 mm	200 mm	50 mm
6040-14-300	0,01 mm	300 mm	60 mm

Posuvná měřítka | Calipers | Suwmiarki

Posuvné měřítka digitální solární
Digital Solar Caliper
Suwmiarka elektroniczna, fotowoltaiczna

0,01

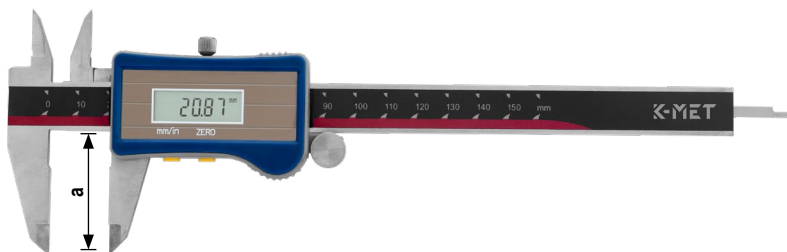

CODE			a [mm]
6040-15-150	0,01 mm	150 mm	40 mm
6040-15-200	0,01 mm	200 mm	40 mm
6040-15-300	0,01 mm	300 mm	40 mm

Posuvné měřítka digitální - bez horních nožů
Digital Caliper - without upper jaws
Suwmiarka elektroniczna - bez górnych noży

0,01

DIN 862

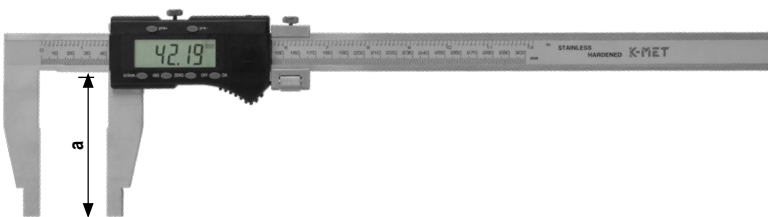

CODE			a [mm]
6042-20	0,01 mm	300 mm	90 mm

Posuvné měřítka digitální nožové
Digital Blade Caliper
Suwmiarka elektroniczna specjalna

0,01

DIN 862



CODE			a [mm]	b [mm]
6040-75-200	0,01 mm	200 mm	70	17
6040-75-210	0,01 mm	200 mm	100	20

Digitální posuvné měřítka s Bluetooth, carbon (uhlíkové vlákno)
Digital Caliper with Bluetooth, carbon fibre
Suwmiarka cyfrowa z Bluetooth, karbon



0,01

DIN 862

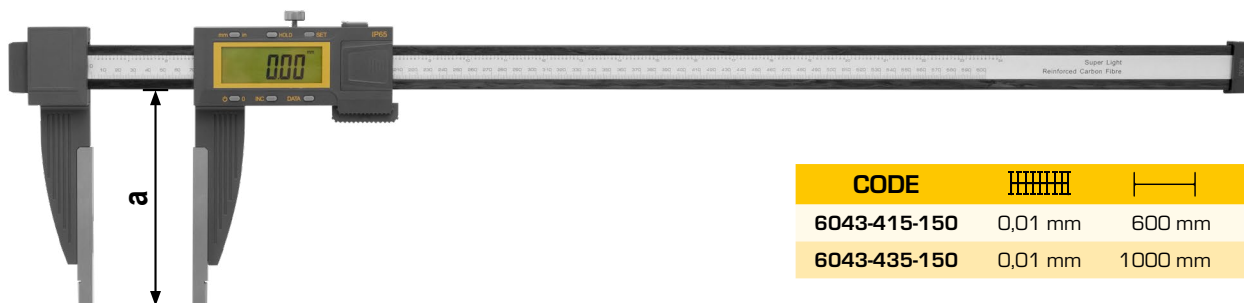

CODE			a [mm]	
6043-415-150	0,01 mm	600 mm	150 mm	1250 g
6043-435-150	0,01 mm	1000 mm	150 mm	2450 g

Posuvná měřítka | Calipers | Suwmiarki

Posuvné měřítko digit. - bez horních noží
 Digital Caliper with Locking Screw & Fine Adjustment
 Suwmiarka elektr. - bez górných noží

0,01

DIN
862

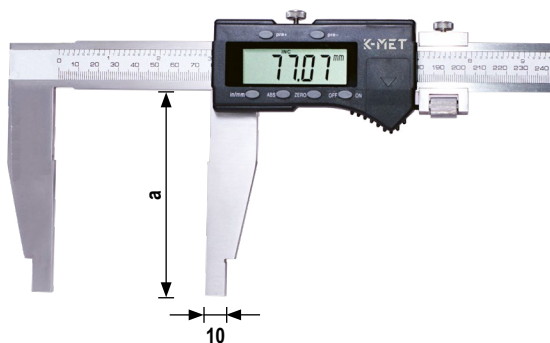

Posuvné měřítko digit. - s horními noží
 Digital Caliper with Locking Screw & Fine Adjustment
 Suwmiarka elektr. - z górnými nožami

0,01

DIN
862

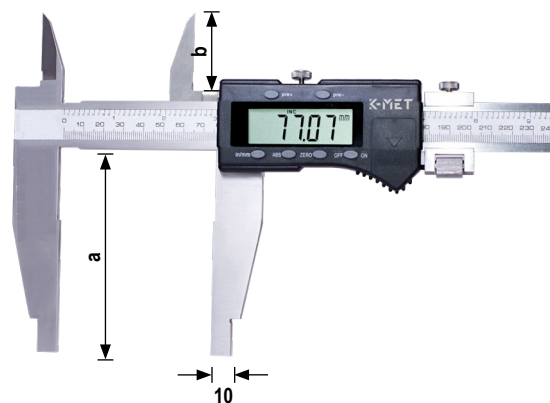

CODE			a [mm]
6043-65-100	0,01 mm	400 mm	100
6043-05-100	0,01 mm	500 mm	100
6043-05-125	0,01 mm	500 mm	125
6043-05-150	0,01 mm	500 mm	150
6043-05-200	0,01 mm	500 mm	200
6043-15-100	0,01 mm	600 mm	100
6043-15-125	0,01 mm	600 mm	125
6043-15-150	0,01 mm	600 mm	150
6043-15-200	0,01 mm	600 mm	200
6043-15-300	0,01 mm	600 mm	300
6043-25-125	0,01 mm	800 mm	125
6043-25-150	0,01 mm	800 mm	150
6043-35-125	0,01 mm	1000 mm	125
6043-35-150	0,01 mm	1000 mm	150
6043-45-150	0,01 mm	1500 mm	150
6043-45-200	0,01 mm	1500 mm	200
6043-45-300	0,01 mm	1500 mm	300
6043-55-150	0,01 mm	2000 mm	150
6043-75-200	0,01 mm	2500 mm	200
6043-75-300	0,01 mm	2500 mm	300

CODE			a [mm]	b [mm]
6044-65-150	0,01 mm	400 mm	150	38
6044-05-100	0,01 mm	500 mm	100	38
6044-05-125	0,01 mm	500 mm	125	51,5
6044-05-150	0,01 mm	500 mm	150	51,5
6044-05-200	0,01 mm	500 mm	200	51,5
6044-15-100	0,01 mm	600 mm	100	38
6044-15-125	0,01 mm	600 mm	125	51,5
6044-15-150	0,01 mm	600 mm	150	51,5
6044-15-200	0,01 mm	600 mm	200	51,5
6044-25-125	0,01 mm	800 mm	125	51,5
6044-25-150	0,01 mm	800 mm	150	51,5
6044-35-125	0,01 mm	1000 mm	125	51,5
6044-35-150	0,01 mm	1000 mm	150	51,5
6044-45-150	0,01 mm	1500 mm	150	61
6044-55-150	0,01 mm	2000 mm	150	61
6044-55-200	0,01 mm	2000 mm	200	61

Od 500mm dodáváno včetně protokolu o přeměření
 From 500 mm supplied with the Measuring Protocol
 Od 500 mm dostarczamy wraz z protokołem o przemierzeniu.

Posuvná měřítka | Calipers | Suwmiarki

Posuvné měřítka digitální na zápichy vnitřní ABZ DESIGN
 Digital Groove Inside Caliper - ABZ DESIGN
 Suwmiarka elektroniczna do kanałków wewnętrznych ABZ DESIGN

0,01

DIN
862

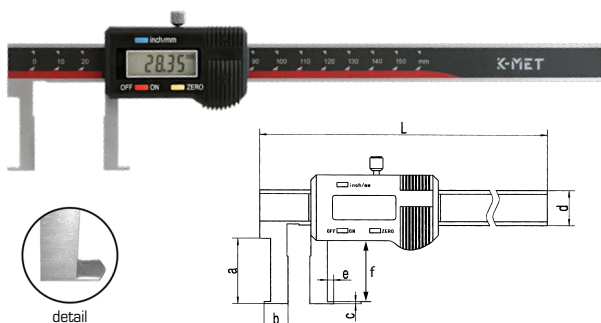

CODE	L [mm]	a [mm]	b [mm]	c [mm]	d [mm]	e [mm]	f [mm]
6040-55-150	22 - 150 mm	250	30	11	1,0	16	5
6040-55-200	25 - 200 mm	310	40	12	1,0	16	5
6040-55-300	30 - 300 mm	410	50	15	1,5	17	5

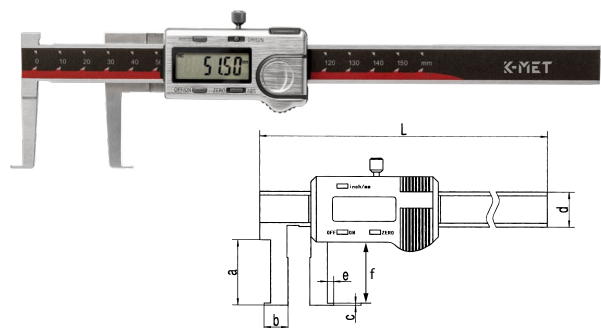

do malých otvorů | do malých otvorov | w małych otworów

CODE	L [mm]	a [mm]	b [mm]	c [mm]	d [mm]	e [mm]	f [mm]
6040-55-151	14 - 150 mm	236	30	12	1,0	16	5

Posuvné měřítka digitální na zápichy vnější ABZ DESIGN
 Digital Groove Outside Caliper - ABZ DESIGN
 Suwmiarka elektroniczna do kanałków zewnętrznych ABZ DESIGN

0,01

DIN
862

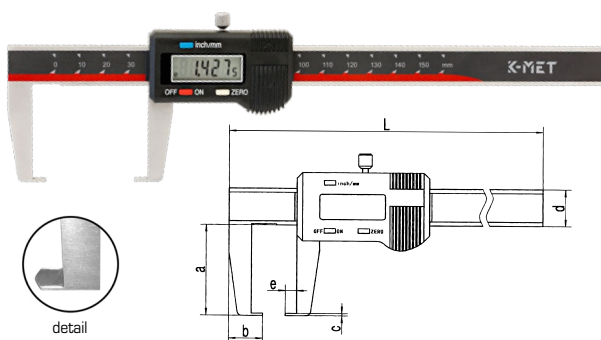

CODE	L [mm]	a [mm]	b [mm]	c [mm]	d [mm]	e [mm]
6040-65-150	0 - 150 mm	250,0	40,0	15,0	1,0	16,0
6040-65-200	0 - 200 mm	310,0	50,0	19,0	1,0	16,0
6040-65-300	0 - 300 mm	400,0	60,0	21,0	1,5	17,0

Posuvné měřítka digitální na ozubená kola
 Digital Gear Tooth Caliper
 Suwmiarka elektroniczna do kół zębatych

0,01

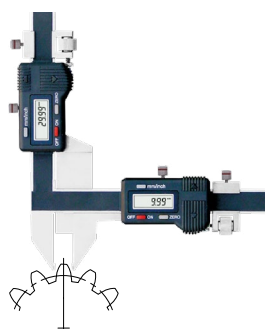

CODE	L [mm]
6041-15-025	M1 - 25
6041-15-050	M5 - 50

Posuvné měřítka digitální na brzdové bubny
 Digital Disc Brake Caliper
 Suwmiarka elektroniczna do tarcz hamulcowych

0,01



CODE	L [mm]
6041-35-060	0 - 60 mm
6041-35-100	0 - 100 mm

Posuvná měřítka | Calipers | Suwmiarki

Posuvné měřítko digitální na měření síly trubek
Digital Caliper for Tube Thickness
Suwmiarka elektroniczna do pom. grubości rurek

0,01

DIN
862

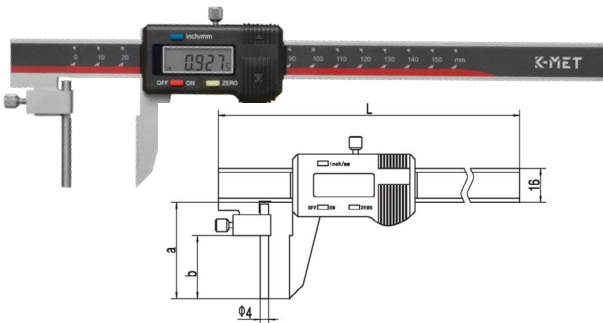

CODE	Range	L [mm]	a [mm]	b [mm]
6040-85-150	0 - 150 mm	250	46	30
6040-85-200	0 - 200 mm	300	56	40
6040-85-300	0 - 300 mm	400	66	50

Posuvné měřítko na měření průměru lan
Digital Rope Caliper
Przymiar kreskowy nastawny elektroniczny

NEW

0,01

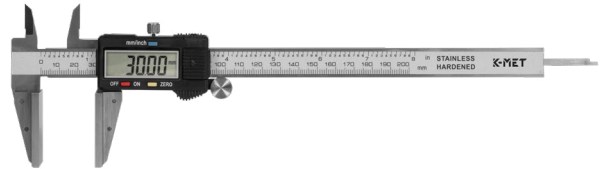

CODE	Range
6041-75-200	0 - 200 mm

Posuvné měřítko rýsovací s výměnným hrotem
Marking Caliper with Replaceable Tip
Suwmiarka traserska z rysikiem, grottem węglkowym

0,01



CODE	Range
6041-55-150	0 - 150 mm
6006-2	náhradní hrot Spare tip zapasowa końcówka

Přípravek na orýsování - digitální
Digital Marking Gauge
Przymiar kreskowy nastawny elektroniczny

0,01



CODE	Range
6041-45-200	0 - 200 mm

Digitální posuv ABZ DESIGN
Digital Scale Unit - ABZ DESIGN
Liniał elektroniczny ABZ DESIGN

DIN
862



VERTIKÁLNÍ | VERTICAL | PIONOWY

CODE	Resolution	L [mm]
6040-45-150	0,01 mm	150 mm
6040-45-200	0,01 mm	200 mm
6040-45-300	0,01 mm	300 mm
6040-45-400	0,01 mm	400 mm
6040-45-500	0,01 mm	500 mm
6040-45-600	0,01 mm	600 mm



HORIZONTÁLNÍ | HORIZONTAL | POZIOMY

CODE	Resolution	L [mm]
6040-35-150	0,01 mm	150 mm
6040-35-200	0,01 mm	200 mm
6040-35-300	0,01 mm	300 mm
6040-35-400	0,01 mm	400 mm
6040-35-500	0,01 mm	500 mm
6040-35-600	0,01 mm	600 mm

Posuvná měřítka | Calipers | Suwmiarki

Náhradní čelisti pro posuvná měřítka
Replacement jaws for calipers
Wymienne szczęki do suwmierek



CODE
6040-00-155

Nástavec pro digitální posuvná měřítka do 300mm
Extension for Digital Calipers up to 300mm
Przedłużacz elektronicznych suwmierek do 300 mm



CODE
6040-00-075

Posuvné plastové měřítko - HOBBY
Digital Caliper Plastic - HOBBY
Suwmiarka analogowa z tworzywa sztucznego - HOBBY

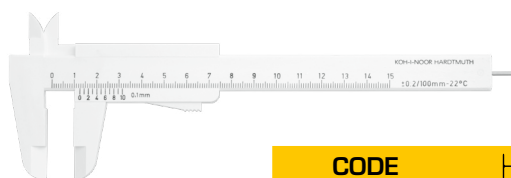

CODE 
6050 150/40 mm

Náhradní baterie
Spare battery
Bateria zapasowa



6040-1 6040-01 6040-05

CODE	
6040-1	LR44 1,55V
6040-01	CR2032 3V
6040-05	CR1632 3V, Lithium

Digitální posuvné měřítko plastové
Digital Caliper Plastic
Suwmiarka elektroniczna z tworzywa sztucznego





CODE 
6050-02-150 150/40 mm

Lesnické průměrky | Forester Calipers | Suwmiarki leśnicze

Lesnická průměrka s permanentní brzdou a stupnicí s laserovým popisem, Red&Black LINE
Forester Caliper Red&Black LINE
Suwmiarka leśnicza z blokadą z opisem laserowym, Red&Black LINE



1163-1

CODE		
1162-08-050	1 mm	500/255 mm
1162-08-080	1 mm	800/410 mm
1162-08-100	1 mm	1000/410 mm
1162-05-050	5 mm	500/255 mm
1162-05-080	5 mm	800/410 mm
1162-05-100	5 mm	1000/410 mm
1163-1	náhradní madlo spare handle uchwyt wymienny	pár pair para

Mikrometry | Micrometres | Mikrometry

Mikrometr třmenový
Outside Micrometer
Mikrometr zewnętrzny

0,01

ČSN
25 1420

DIN
863

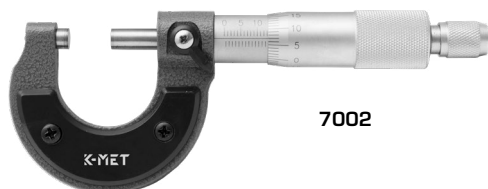

7002



7004 - 7008

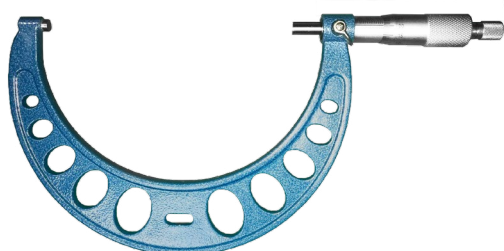

7011 - 7025



7002-12-100
7002-12-200
7002-12-300

CODE		L
7002	0,01 mm	0 - 25 mm
7004	0,01 mm	25 - 50 mm
7006	0,01 mm	50 - 75 mm
7008	0,01 mm	75 - 100 mm
7011	0,01 mm	100 - 125 mm
7013	0,01 mm	125 - 150 mm
7015	0,01 mm	150 - 175 mm
7017	0,01 mm	175 - 200 mm
7019	0,01 mm	200 - 225 mm
7021	0,01 mm	225 - 250 mm
7023	0,01 mm	250 - 275 mm
7025	0,01 mm	275 - 300 mm
7002-12-100	0,01 mm	0 - 100 mm
7002-12-200	0,01 mm	100 - 200 mm
7002-12-300	0,01 mm	200 - 300 mm
7026	0,01 mm	300 - 400 mm
7027	0,01 mm	400 - 500 mm
7027-1	0,01 mm	500 - 600 mm
7027-2	0,01 mm	600 - 700 mm
7027-3	0,01 mm	700 - 800 mm
7027-4	0,01 mm	800 - 900 mm
7027-5	0,01 mm	900 - 1000 mm

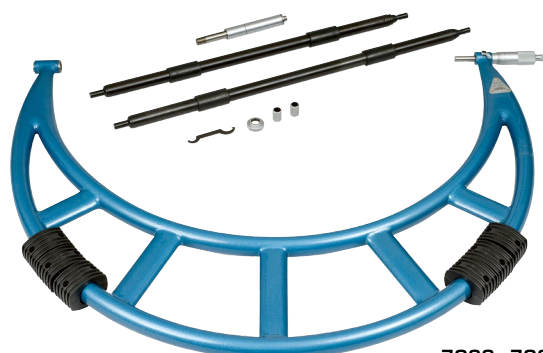

7026 - 7027-5

Dodáváno včetně nastavovacího kalibru.
Supplied with Setting Gauge.
Dostarczamy wraz z krążkiem ustawiającym.

Mikrometry | Micrometres | Mikrometry

Mikrometr třmenový - PROFESSIONAL
 Outside Micrometer - PROFESSIONAL
 Mikrometr zewnętrzny - PROFESSIONAL

DIN
863

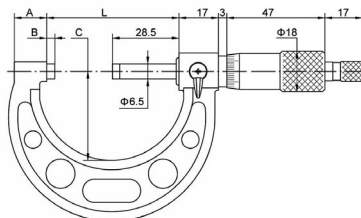

CODE		
7002-02-025	0,01 mm	0 - 25 mm

Nastavovací kalibr mikrometru
 Setting Gauge for Micrometers
 Wzorzec nastawczy do mikrometru

DIN
863



CODE	
7002-00-025	25 mm
7002-00-050	50 mm
7002-00-075	75 mm
7002-00-100	100 mm

Nástavce na závity - pár
 V-shaped and Knife Anvils - pair
 Końcówki mikrometru do pomiaru gwintu - para



CODE		stoupání stúpanie rosnać
7028-41	60°	0,40 - 0,50 mm
7028-42	60°	0,60 - 0,90 mm
7028-43	60°	1,00 - 1,75 mm
7028-44	60°	2,00 - 3,00 mm
7028-45	60°	3,50 - 5,00 mm
7028-46	60°	5,50 - 7,00 mm

Mikrometr třmenový na závity
 Screw Thread Micrometer
 Mikrometr do gwintu

DIN
863



Mikrometr třmenový digitální na závity
 Digital Screw Thread Micrometer
 Mikrometr elektroniczny do gwintu

DIN
863



Nástavce na závity součástí balení.
 Anvils are included in the package.
 Końcówki mikrometru są w opakowaniu.

CODE		
7028-31	0,01 mm	0 - 25 mm
7028-32	0,01 mm	25 - 50 mm
7028-33	0,01 mm	50 - 75 mm
7028-34	0,01 mm	75 - 100 mm
7028-35	0,01 mm	100 - 125 mm
7028-36	0,01 mm	125 - 150 mm
7028-37	0,01 mm	150 - 175 mm
7028-38	0,01 mm	175 - 200 mm

CODE		
7028-02-025	0,001 mm	0 - 25 mm
7028-02-050	0,001 mm	25 - 50 mm
7028-02-075	0,001 mm	50 - 75 mm
7028-02-100	0,001 mm	75 - 100 mm

Mikrometry | Micrometres | Mikrometry

Mikrometr K-MET Labo ICONIC - třmenový, digitální
 Digital Outside Micrometer K-MET ICONIC Labo
 Mikrometr K-MET Labo ICONIC - zewnętrzny, elektroniczny



0,001



IP 65

DIN 863



Dodáváno včetně protokolu o přeměření
 Supplied with the Measuring Protocol
 Dostarczany wraz z protokołem o przemierzeniu



BLUETOOTH PROFILE

Integrovaný bezdrátový přenos dat přes Bluetooth
 pro základní použití se k připojení jako zařízení standardu HID,
 není potřeba žádný další software

Integrated wireless data transfer via Bluetooth
 for basic use, connect as HID standard device,
 no additional software is needed.

Zintegrowany bezprzewodowy transfer danych poprzez Bluetooth.
 Do codziennego użytkowania. Podłącz jako urządzenie standardowe HID,
 żadne dodatkowe oprogramowanie nie jest potrzebne.

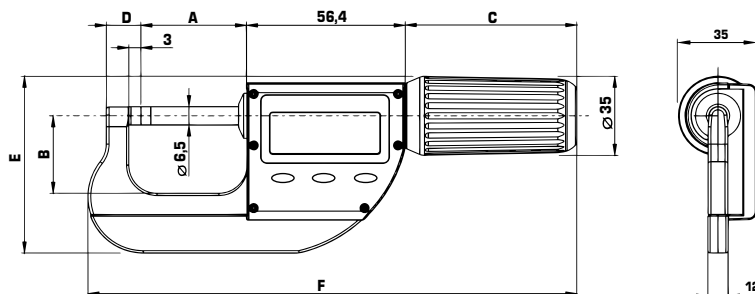

CODE		A [mm]	B [mm]	C [mm]	D [mm]	E [mm]	F [mm]
7033-95-025	0 - 25 mm	30	23	43	12	65	155
7033-95-050	25 - 50 mm	53	30	43	12	82	185
7033-95-075	50 - 75 mm	78	44	43	12	96	212
7033-95-100	75 - 100 mm	103	56	43	12	115	238

- » Ochrana IP65
- » Induktivní měřicí systém
- » Automatické zapnutí pohybem DIGI jednotky
- » Paměť poslední měřené hodnoty
- » Maximální rychlost pohybu 3,2m/s
- » Dotyky z tvrdokovu
- » Automatické vypnutí displeje při nečinnosti
- » Přesnost dle DIN 863
- » Integrovaný Bluetooth modul, API pro připojení softwarových aplikací
- » Protection IP65
- » Inductive measuring system
- » Automatic switching on by moving the DIGI unit
- » Memory of the last measured value
- » Maximum movement speed 3.2m/s
- » Carbide touches
- » Automatic display shutdown during inactivity
- » Accuracy according to DIN 863
- » Integrated Bluetooth module, API for connecting software applications
- » Ochrana IP65
- » Indukcyjny system pomiarowy
- » Automacyjne włączenie poprzez przesunięcie jednostki DIGI
- » Pamięć ostatniej zmierzonej wartości
- » Maksymalna prędkość ruchu 3.2m/s
- » Końcówki węglkowe
- » Automacyjne wyłączenie wyświetlacza podczas bezczynności
- » Dokładność wg DIN 863
- » Zintegrowany moduł Bluetooth, API do łączenia aplikacji oprogramowania

Digitální mikrometr třmenový
 Digital Outside Micrometer
 Mikrometr elektroniczny zewnętrzny

IP 65



CODE	
7032-02-100	0 - 100 mm
7032-02-200	100 - 200 mm
7032-02-300	200 - 300 mm
7032-02-400	300 - 400 mm
7032-02-500	400 - 500 mm
7032-02-600	500 - 600 mm
7032-02-700	600 - 700 mm
7032-02-800	700 - 800 mm
7032-02-900	800 - 900 mm
7032-02-1000	900 - 1000 mm

Mikrometry | Micrometres | Mikrometry

Mikrometr K-MET ABSOLUTE ZERO - třmenový, digitální
 Digital Outside Micrometer K-MET ABSOLUTE ZERO
 Mikrometr K-MET ABSOLUTE ZERO - zewnętrzny, elektroniczny

INOX 0,001 DATA ABZ IP 65 DIN 863

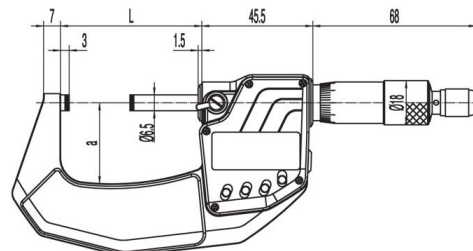

Dodáváno včetně nastavovacího kalibru.
 Supplied with Setting Gauge.
 Dostarczamy wraz z krążkiem ustawiającym.

CODE		L [mm]	a [mm]
7030-05-025	0 - 25 mm	33,0	25,0
7030-05-050	25 - 50 mm	58,0	32,5
7030-05-075	50 - 75 mm	83,0	47,5
7030-05-100	75 - 100 mm	108,0	60,0

Mikrometr třmenový digitální
 Digital Outside Micrometer
 Mikrometr zewnętrzny elektroniczny

0,001 IP 65 DIN 863

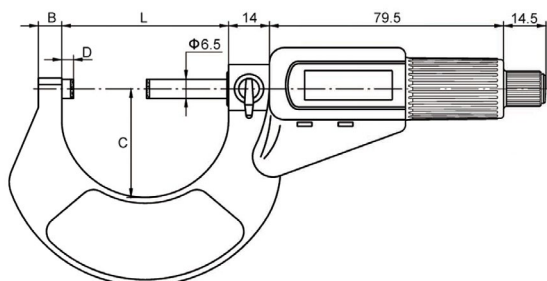

CODE	B [mm]	C [mm]	D [mm]	L [mm]	
7031-02-025	6	27,5	3	32	0 - 25 mm
7031-02-050	8	37,0	3	57	25 - 50 mm
7031-02-075	8	50,0	3	82	50 - 75 mm
7031-02-100	10	61,0	3	107	75 - 100 mm
7031-02-125	16	72,0	3	132	100 - 125 mm
7031-02-150	18	85,0	3	158	125 - 150 mm
7031-02-175	20	105,0	3	185	150 - 175 mm
7031-02-200	25	122,0	3	215	175 - 200 mm

Mikrometry | Micrometres | Mikrometry

Mikrometrický tloušťkoměr digitální
Digital Thickness Gauge
Grubościomierz elektroniczny

0,01

DIN
863



CODE		d [mm]	
7040-1	0,01 mm	9	0 - 25 mm

Mikrometrický tloušťkoměr digitální ABZ
Digital Thickness Gauge ABZ
Grubościomierz elektroniczny ABZ

0,01

DIN
863

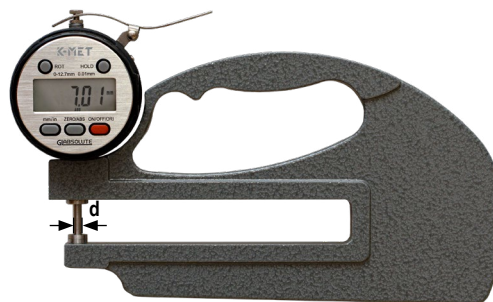

CODE		d [mm]	
7040-05-010	0,01 mm	9	0 - 10/30 mm
7040-15-010	0,01 mm	9	0 - 10/120 mm

Mikrometr na trubky
Tube Micrometer
Mikrometer do rur

0,01

DIN
863



CODE		
7041	0,01 mm	0 - 25 mm

Mikrometr na trubky digitální
Digital Tube Micrometer
Mikrometer elektroniczny do rur

IP 65

0,001

DIN
863



CODE	B [mm]	C [mm]	D [mm]	L [mm]		
7041-02-025	6,0	25,0	3,0	34,5	0,001 mm	0 - 25 mm
7041-02-050	8,0	32,0	3,0	59,5	0,001 mm	25 - 50 mm

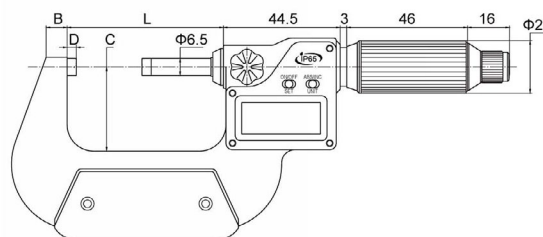

Mikrometry | Micrometres | Mikrometry

Mikrometr na drát
Wire Micrometer
Mikrometr do drutu

0,01

ČSN
25 1456



CODE

7043



0 - 10 mm

Mikrometr třmenový na ozubená kola
Disc Micrometer
Mikrometr do kól zębatých

0,01

ČSN
25 1456

Mikrometr třmenový na ozubená kola - digitální
Digital Disc Micrometer
Mikrometr do kól zębatých - elektroniczny

0,001

DIN
863



CODE	d [mm]	
7051	20	0 - 25 mm
7052	20	25 - 50 mm
7053	20	50 - 75 mm
7054	20	75 - 100 mm
7055	30	100 - 125 mm
7056	30	125 - 150 mm
7057	30	150 - 175 mm
7058	30	175 - 200 mm

CODE	d [mm]	
7070-02-025	20	0 - 25 mm
7070-02-050	20	25 - 50 mm
7070-02-075	20	50 - 75 mm
7070-02-100	20	75 - 100 mm
7070-02-125	30	100 - 125 mm
7070-02-150	30	125 - 150 mm
7070-02-175	30	150 - 175 mm
7070-02-200	30	175 - 200 mm

Mikrometr na zápichy
Blade Micrometer
Mikrometr do kanałków zewnętrznych

0,01

DIN
863

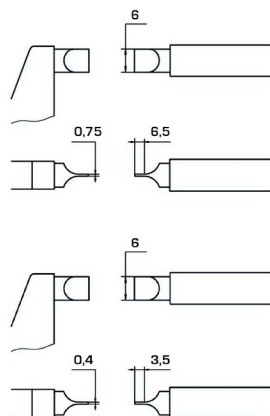

CODE	
7075-02-025	0 - 25 mm
7075-02-050	25 - 50 mm
7075-02-075	50 - 75 mm
7075-02-100	75 - 100 mm
7075-02-125	100 - 125 mm
7075-02-150	125 - 150 mm
7075-02-175	150 - 175 mm

CODE	
7076-02-025	0 - 25 mm

Mikrometry | Micrometres | Mikrometry

Mikrometr na zápichy - digitální, rychloposuv

Blade Micrometer

Mikrometr do kanálků zewnětržnych - elektronický, szybki



0,001

DIN
863



CODE	
7075-05-025	0 - 25 mm
7075-05-050	25 - 50 mm
7075-05-075	25 - 75 mm
7075-05-100	75 - 100 mm
7075-05-125	100 - 125 mm
7075-05-150	125 - 150 mm
7075-05-175	150 - 175 mm

CODE	
7076-05-025	0 - 25 mm

Mikrometr digitální s hroty 30°

Digital Blade Micrometer 30°

Mikrometr elektroniczny z końcówkami 30°

0,001

DIN
863



CODE	
7077-05-025	0 - 25 mm

Mikrometr dvoudotekový dutinový (dutinoměr)

Internal Jaw Micrometer

Mikrometr wewnętrzny

0,01

DIN
863

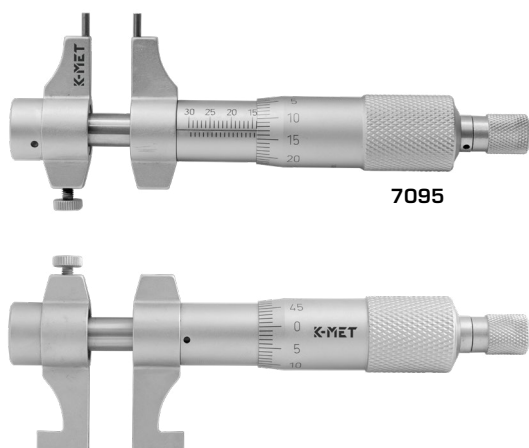

CODE		0
7095	5 - 30 mm	5mm
7096	25 - 50 mm	25mm
7097	50 - 75 mm	-
7098	75 - 100 mm	-
7098-1	100 - 125 mm	-
7098-2	125 - 150 mm	-
7098-3	150 - 175 mm	-
7098-4	175 - 200 mm	-
7098-5	200 - 225 mm	-
7098-6	225 - 250 mm	-
7098-7	250 - 275 mm	-
7098-8	275 - 300 mm	-

Mikrometry | Micrometres | Mikrometry

Mikrometr dutinový dvoudotekový (dutinoměr) - digitální
 Digital Internal Jaw Micrometer
 Mikrometr wewnętrzny - elektroniczny

0,001

DIN
863



7100-02-030



CODE		0
7100-02-030	5 - 30 mm	5 mm
7100-02-050	25 - 50 mm	25 mm
7100-02-075	50 - 75 mm	-
7100-02-100	75 - 100 mm	-

DALŠÍ ROZMĚRY NA ZAKÁZKU
 OTHER SIZES ON REQUEST
 INNE WYMIARY NA ZAMÓWIENIE

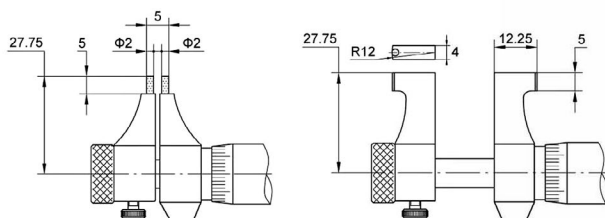

Mikrometrická hlavice
 Micrometer Head
 Głowica mikrometryczna

DIN
863



CODE		
7120	0,01 mm	0 - 25 mm

Mikrometrický hloubkoměr
 Depth Micrometer
 Głębokościomierz mikrometryczny

DIN
863



7103-02-025



7103

CODE			
7103	0,01 mm	0 - 100 mm	analog
7103-02-025	0,001 mm	0 - 25 mm	digital

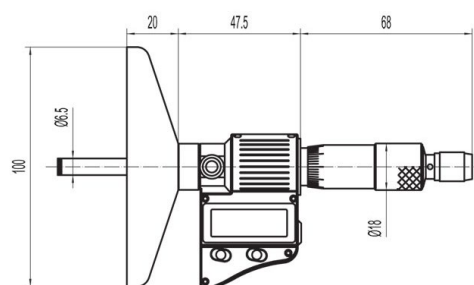

Mikrometry | Micrometres | Mikrometry

Mikrometr třídotekový (dutinoměr) - SADA, NOVÝ MODEL V HLINÍKOVÉM KUFRU

3-point Internal Micrometer with Setting Rings - SET, NEW MODEL, Al box

Średnicówka mikrometryczna do małych otworów - ZESTAW, NOWY MODEL W ALUMINIOWEJ OBUDOWIE

002 - 012
0,001

020 - 100
0,005

DIN
863



7089-03-040

CODE	⌀	— —	sestava zostava zestaw	0
7089-03-003	0,004 mm	2 - 3 mm	2 - 2,5, 2,5 - 3 mm	2,5 mm
7089-03-006	0,004 mm	3 - 6 mm	3 - 4, 4 - 5, 5 - 6 mm	4, 5, 6 mm
7089-03-012	0,004 mm	6 - 12 mm	6 - 8, 8 - 10, 10 - 12 mm	6, 8, 10 mm
7089-03-020	0,004 mm	12 - 20 mm	12 - 16, 16 - 20 mm	16 mm
7089-03-040	0,004 mm	20 - 40 mm	20 - 25, 25 - 30, 30 - 40 mm	25, 40 mm
7089-03-100	0,005 mm	40 - 100 mm	40 - 50, 50 - 63, 62 - 75, 75 - 88, 87 - 100 mm	40, 62, 87 mm

7089-03-003, 7089-03-006 - pouze 2 doteky | only 2 touches | dwupunktowa

Mikrometr třídotekový (dutinoměr), NOVÝ MODEL V HLINÍKOVÉM KUFRU

3-point Internal Micrometer with Setting Rings - NEW MODEL, Al box

Średnicówka mikrometryczna do małych otworów, NOWY MODEL W ALUMINIOWEJ OBUDOWIE

002 - 012
0,001

016 - 300
0,005

225 - 300
0,007

DIN
863



7089-02-040



7089-02-100

CODE	⌀	— —	0
7089-02-002	0,004 mm	2 - 2,5 mm	2,5 mm
7089-02-003	0,004 mm	2,5 - 3 mm	2,5 mm
7089-02-004	0,004 mm	3 - 4 mm	4 mm
7089-02-005	0,004 mm	4 - 5 mm	5 mm
7089-02-006	0,004 mm	5 - 6 mm	6 mm
7089-02-008	0,004 mm	6 - 8 mm	6 mm
7089-02-010	0,004 mm	8 - 10 mm	8 mm
7089-02-012	0,004 mm	10 - 12 mm	10 mm
7089-02-016	0,004 mm	12 - 16 mm	16 mm
7089-02-020	0,004 mm	16 - 20 mm	16 mm
7089-02-025	0,004 mm	20 - 25 mm	25 mm
7089-02-030	0,004 mm	25 - 30 mm	25 mm
7089-02-040	0,004 mm	30 - 40 mm	40 mm
7089-02-050	0,005 mm	40 - 50 mm	40 mm
7089-02-063	0,005 mm	50 - 63 mm	62 mm
7089-02-075	0,005 mm	62 - 75 mm	62 mm
7089-02-088	0,005 mm	75 - 88 mm	87 mm
7089-02-100	0,005 mm	87 - 100 mm	87 mm
7089-02-125	0,005 mm	100 - 125 mm	-
7089-02-150	0,005 mm	125 - 150 mm	-
7089-02-175	0,005 mm	150 - 175 mm	-
7089-02-200	0,005 mm	175 - 200 mm	-
7089-02-225	0,007 mm	200 - 225 mm	-
7089-02-250	0,007 mm	225 - 250 mm	-
7089-02-275	0,007 mm	250 - 275 mm	-
7089-02-300	0,007 mm	275 - 300 mm	-

Mikrometry jsou dodávány včetně prodloužení
100 mm (do pr. 12 mm) nebo 150 mm (od pr. 12mm)

Micrometers are supplied with extension
100 mm (to ø 12mm) or 150 mm (from ø 12mm)

Mikrometry są dostarczane wraz z przedłużeniem
100 mm (do śred. 12 mm) lub 150 mm (od śred. 12 mm)

DALŠÍ ROZMĚRY NA ZAKÁZKU
OTHER SIZES ON REQUEST
INNE WYMIARY NA ZAMÓWIENIE

Mikrometry | Micrometres | Mikrometry

Mikrometr třídotekový (dutinoměr) digitální - Al box, SADA
 3-point Digital Internal Micrometer with Setting Rings - SET, NEW MODEL, Al box
 Średnicówka mikrometryczna trójpunktowa elektroniczna - Al box, ZESTAW



0,001

DIN
863



7090-03-100

CODE		prodl. predí. przedł.	O
7090-03-003	2 - 3 mm	2 - 2,5, 2,5 - 3 mm	2,5 mm
7090-03-006	3 - 6 mm	3 - 4, 4 - 5, 5 - 6 mm	4, 5, 6 mm
7090-03-012	6 - 12 mm	6 - 8, 8 - 10, 10 - 12 mm	6, 8, 10 mm
7090-03-020	12 - 20 mm	12 - 16, 16 - 20 mm	16 mm
7090-03-050	20 - 50 mm	20 - 25, 25 - 30, 30 - 40, 40 - 50 mm	25, 40 mm
7090-03-100	50 - 100 mm	50 - 63, 62 - 75, 75 - 88, 87 - 100 mm	62, 87 mm

7090-03-003, 7090-03-006 - pouze 2 doteky | only 2 touches | dwupunktowa

Mikrometr třídotekový (dutinoměr) digitální - Al box
 3-point Digital Internal Micrometer with Setting Rings, NEW MODEL, Al box
 Średnicówka mikrometryczna trójpunktowa elektroniczna - Al box



0,001

DIN
863



7090-02-088

Mikrometry jsou dodávány včetně prodloužení
 100 mm (do pr. 12 mm) nebo 150 mm (od pr. 12 mm)

Micrometers are supplied with extension
 100 mm (to ø 12mm) or 150 mm (from ø 12mm)

Mikrometry są dostarczane wraz z przedłużeniem
 100 mm (do śred. 12 mm) lub 150 mm (od śred. 12 mm)

Mikrometry malých průměrů (do pr. 6 mm)
 jsou dodávány pouze se 2 dotyky

Micrometers of small diameters (up to 6 mm diameter)
 they only come with 2 touches

Mikrometry o malých średnicach (do śred. 6 mm)
 są dwupunktowe

CODE		O
7090-02-002	2 - 2,5 mm	2,5 mm
7090-02-003	2,5 - 3 mm	2,5 mm
7090-02-004	3 - 4 mm	4 mm
7090-02-005	4 - 5 mm	5 mm
7090-02-006	5 - 6 mm	6 mm
7090-02-008	6 - 8 mm	6 mm
7090-02-010	8 - 10 mm	8 mm
7090-02-012	10 - 12 mm	10 mm
7090-02-016	12 - 16 mm	16 mm
7090-02-020	16 - 20 mm	16 mm
7090-02-025	20 - 25 mm	25 mm
7090-02-030	25 - 30 mm	25 mm
7090-02-040	30 - 40 mm	40 mm
7090-02-050	40 - 50 mm	40 mm
7090-02-063	50 - 63 mm	62 mm
7090-02-075	62 - 75 mm	62 mm
7090-02-088	75 - 88 mm	87 mm
7090-02-100	87 - 100 mm	87 mm
7090-02-125	100 - 125 mm	-
7090-02-150	125 - 150 mm	-
7090-02-175	150 - 175 mm	-
7090-02-200	175 - 200 mm	-
7090-02-225	200 - 225 mm	-
7090-02-250	225 - 250 mm	-
7090-02-275	250 - 275 mm	-
7090-02-300	275 - 300 mm	-

Mikrometry | Micrometres | Mikrometry

Mikrometr dutinový (dutinoměr) - analogový úchylkoměr
Dial Bore Gauge with Dial Micrometer
Średnicówka czujnikowa dwupunktowa - analogowa

DIN
863



Mikrometr dutinový (dutinoměr) - digitální úchylkoměr
Dial Bore Gauge with Digital Micrometer
Średnicówka czujnikowa dwupunktowa - elektroniczna

DIN
863



ilustrační foto | illustration photo | zdjęcie ilustracyjne

CODE	Resolution	Range
7110-0	0,01 mm	6 - 10 mm
7110-1	0,01 mm	10 - 18 mm
7110-2	0,01 mm	18 - 35 mm
7110-3	0,01 mm	35 - 50 mm
7110-5	0,01 mm	50 - 160 mm
7110-6	0,01 mm	160 - 250 mm
7110-7	0,01 mm	250 - 450 mm

CODE	Resolution	Range
7110-80	0,001 mm	6 - 10 mm
7110-81	0,001 mm	10 - 18 mm
7110-82	0,001 mm	18 - 35 mm
7110-83	0,01 mm	35 - 50 mm
7110-85	0,01 mm	50 - 160 mm
7110-86	0,01 mm	160 - 250 mm
7110-87	0,01 mm	250 - 450 mm

Mikrometr dutinový (dutinoměr) - analogový úchylkoměr
Dial Bore Gauge with Dial Micrometer
Średnicówka czujnikowa dwupunktowa - analogowa

DIN
863



Mikrometrické odpichy
Internal Measurement Micrometer
Średnicówka mikrometryczna składana

DIN
863



CODE	Resolution	Range
7110-90	0,001 mm	6 - 10 mm
7110-91	0,001 mm	10 - 18 mm
7110-92	0,001 mm	18 - 35 mm
7110-93	0,001 mm	35 - 50 mm
7110-94	0,001 mm	50 - 160 mm
7110-95	0,001 mm	160 - 250 mm
7110-96	0,001 mm	250 - 450 mm

CODE	Resolution	Range
7125-12	0,01 mm	50 - 75 mm
7125	0,01 mm	50 - 600 mm
7125-3	0,01 mm	100 - 2100 mm
7125-00-100	nástavec extension przedłużenie 100 mm	
7125-00-200	nástavec extension przedłużenie 200 mm	

Mikrometry | Micrometres | Mikrometry

Pasometr - Profesional
 Indicator Micrometer Professional
 Mikrometr z czujnikiem - Profesional (transametr)

DIN
863

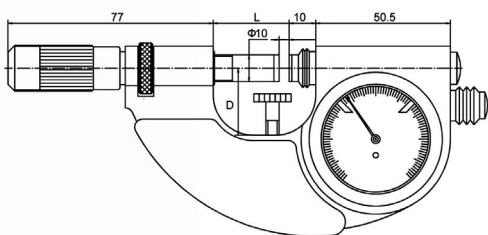

CODE	L [mm]	D [mm]	Resolution	Range
7126-02-025	28,5	25,0	0,001 mm	0 - 25 mm
7126-02-050	53,5	35,0	0,001 mm	25 - 50 mm
7126-02-075	78,5	47,5	0,001 mm	50 - 75 mm
7126-02-100	103,5	60,0	0,001 mm	75 - 100 mm

Dodáváno včetně protokolu o přeměření.
 Supplied with the Measuring Protocol.
 Dostarczamy wraz z protokołem z przemierzenia.

Pasometr (mikropasometr)
 Indicator Micrometer
 Mikrometr z czujnikiem (transametr)

DIN
863



CODE	Resolution	Range
7126	0,001 mm	0 - 25 mm
7126-1	0,001 mm	25 - 50 mm
7126-2	0,001 mm	50 - 75 mm
7126-3	0,001 mm	75 - 100 mm

Digitální Pasometr (mikropasometr)
 Digital Indicator Micrometer
 Mikrometr cyfrový z czujnikiem (transametr)



CODE	Resolution	Range
7126-95-025	0,0002 mm	0 - 25 mm
7126-95-050	0,0002 mm	25 - 50 mm
7126-95-075	0,0002 mm	50 - 75 mm
7126-95-100	0,0002 mm	75 - 100 mm

Dodáváno včetně protokolu o přeměření.
 Supplied with the Measuring Protocol.
 Dostarczamy wraz z protokołem o przemierzeniu.



7126-95-025

Svinovací metry | Measuring Tapes | Miary zwijane

Svinovací metr - doporučujeme pro kalibrace
Tape Measure - Recommended for Calibration
Miara zwijana - zalecana do wzorcowania



CODE	Length	Width
8001	2 m	13 mm
8002	3 m	13 mm
8003	5 m	16 mm

Svinovací metr
Tape Measure
Miara zwijana



CODE	Length	Width
8002-02-003	3 m	13 mm
8002-02-005	5 m	19 mm
8002-02-008	8 m	25 mm
8002-02-010	10 m	25 mm

Svinovací metr
Tape Measure
Miara zwijana



CODE	Length	Width
8001-02-003	3 m	16 mm
8001-02-005	5 m	19 mm
8001-02-008	8 m	25 mm

Svinovací metry | Measuring Tapes | Miary zwijane

Digitální svinovací metr
Digital Tape Measure
Miara zwijana cyfrowa



CODE	Length	Blade Width	Hook Width
8001-05-005	5 m	1 mm	19 mm



Svinovací metr KOMELON - SELF LOCK, otěruvzdorná páska
Tape Measure KOMELON - SELF LOCK, Resistant Tape
Miara zwijana KOMELON - SELF LOCK, odporna na ścieranie



CODE	Length	Blade Width
8039-3	3 m	16 mm
8039-5	5 m	19 mm

Svinovací metr KOMELON - PRO ERGO, otěruvzdorná páska
Tape Measure KOMELON - PRO ERGO, Resistant Tape
Miara zwijana KOMELON - PRO ERGO, odporna na ścieranie



CODE	Length	Blade Width
8040-1	2 m	16 mm
8040-2	3 m	16 mm
8040-3	5 m	19 mm
8040-4	8 m	25 mm

Svinovací metry | Measuring Tapes | Miary zwijane

Svinovací metr KOMELON ECO PEN
Tape Measure KOMELON ECO PEN
Miara zwijana KOMELON ECO PEN



CODE	Length	Width
8041-2	3 m	16 mm
8042-2	5 m	19 mm
8043-2	8 m	25 mm

Svinovací metr KOMELON Combi Pro, otěruvzdorná páska
Tape Measure KOMELON Combi Pro, abrasion-resistant
Miara zwijana KOMELON Combi Pro, odporna na ścieranie



CODE	Length	Width
8042-5	5 m	25 mm

Svinovací metr FESTA - EEC cert., aut. brzda (autolock), pogumování
Tape Measure FESTA - EEC cert., AUTOLOCK, Rubber Case
Miara zwijana FESTA - EEC certifikat, autolock, guma

Svinovací metr FESTA, pogumovaný s magnetem
Tape Measure FESTA, Rubber Case, Magnet on Hook
Miara zwijana FESTA, gumowana z magnesem



CODE	Length	Width
8044-20	3 m	16 mm
8044-21	5 m	19 mm
8044-22	7,5 m	25 mm



CODE	Length	Width
8044-10	2 m	16 mm
8044-11	3 m	16 mm
8044-12	5 m	19 mm
8044-13	7,5 m	25 mm
8044-14	10 m	25 mm



Svinovací metry | Measuring Tapes | Miary zwijane

Svinovací metr JOHNEY
Tape Measure JOHNEY
Miara zwijana JOHNEY



CODE	Length	Width
8040	2 m	13 mm
8041	3 m	13 mm
8042	5 m	13 mm
8042-1	5 m	19 mm
8043	7,5 m	19 mm

Svinovací metr FESTA - velké číslice
Tape Measure FESTA - Large Numbers
Miara zwijana FESTA - z dužými cyframi



CODE	Length	Width
8044-15	2 m	16 mm
8044-16	3 m	19 mm
8044-17	5 m	19 mm

Svinovací metr HOBBY LINE II
Tape Measure HOBBY LINE II
Miara zwijana HOBBY LINE II



CODE	Length	Width
8001-2	2 m	13 mm
8002-2	3 m	13 mm
8003-2	5 m	19 mm
8004-2	7,5 m	25 mm
8004-2-1	10 m	25 mm

Diametr - svinovací metr pro měření průměru
Circumference Tape
Diametr - do pomiaru grubości



CODE	Length	Width
8005	2 m	10 mm

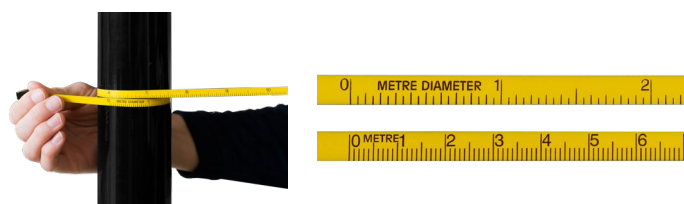

Pásma | Long Tapes | Miary zwijane

Pásmo - ocelová páska, pro kalibrace
Long Steel Tape - Recomm. for Calibration
Taśma stalowa - zalecana do wzorcowania



CODE	Length	Width
8010	10 m	13 mm
8011	20 m	13 mm
8012	25 m	13 mm
8013	30 m	13 mm
8014	50 m	13 mm

Pásmo - ocelová páska, polyamid úprava
Long Steel Tape, polyamid
Taśma stalowa - polyamid



CODE	Length	Width
8017-02-030	30 m	13 mm
8017-02-050	50 m	13 mm

Pásmo s rukojetí, ocelová páska
Long Steel Tape with Handle
Taśma stalowa z uchwytem



CODE	Length	Width
8017	10 m	13 mm
8018	20 m	13 mm
8019	25 m	13 mm
8020	30 m	13 mm
8021	50 m	13 mm

Pásmo KOMELON ve vidlici, sklo-laminátová el. nevodivá páska
Long Steel Tape Komelon KOMELON - Laminate Tape
Taśma KOMELON - widełki, szkło i laminat, nieprzewodząca prąd elektr.



CODE	Length	Width
8054-0	30 m	13 mm
8054-1	50 m	13 mm
8054	100 m	13 mm

Pásma | Long Tapes | Miary zwijane

Pásma KOMELON - sklo-laminátová páska
Long Tape KOMELON - Laminat
Taśma KOMELON szkło - laminat



CODE	Length	Width
8045	10 m	13 mm
8046	20 m	13 mm
8047	30 m	13 mm
8048	50 m	13 mm

Pásma KOMELON, ocelová páska
Long Steel Tape KOMELON
Taśma stalowa KOMELON



CODE	Length	Width
8055	10 m	10 mm
8055-1	20 m	10 mm
8055-2	30 m	10 mm

Pásma FESTA, ocelová páska
Long Steel Tape FESTA with tilttable hook
Taśma stalowa FESTA



CODE	Length	Width
8050	10 m	10 mm
8051	20 m	10 mm
8052	30 m	10 mm
8053	50 m	10 mm

Měřicí kolečko
Measuring wheel
Drogomierz



8057-02-300 8057-15-320 8057-05-320

CODE	Length	Width	Weight	Wheel Diameter	Type
8057-02-300	1010/510 mm	1530 g	D 318 mm	analog	
8057-15-320	1100/620 mm	1700 g	D 318 mm	digital	
8057-05-320	1000/520 mm	2000 g	D 320 mm	digital	

Páska s mm dělením rovná ke strojům 3m, s možností podlepení
Steel Tape with mm graduation for Machines - 3m, with the possibility of gluing
Taśma z mm podziałką 3m, z możliwością klejenia



CODE	Length	Width
8002-10	3 m	13 mm

Na zakázku nabízíme dodání pásky v různých délkách, v bílém nebo žlutém provedení, se stupnicí zleva doprava i zprava doleva.

We offer custom delivery tapes in various lengths, in white or yellow design, with a scale from left to right and right to left.

Oferujemy niestandardowe taśmy w różnych długościach, w kolorze białym lub żółtym w wersji ze skalą od lewej do prawej lub od prawej do lewej.

Sady | Sady | Zestawy

Sada závitových měrek v kufru
Set of thread gauges in the box
Zestaw szczelinomierzy w kufrze



CODE

SK111-32-058



1130

1146

1148

Sada závitových měrek
Set of thread gauges
Zestaw szczelinomierzy do gwintów



CODE

S111-32-058



1130

1146

1148

Sada měřidel v kufru
Measuring Tools Set in the box
Zestaw narzędzi pomiarowych w kufrze



CODE

SK441-32-160



4001-03-075

4003

1061-07-100

Sada měřidel
Measuring Tools Set
Zestaw narzędzi pomiarowych



CODE

S441-32-160



4001-03-075

4003

1061-07-100

Sada zámečnických přílozých úhelníků v kufru
Try Squares Set in the box
Zestaw kątowników ze stopką w kufrze



CODE

SK444-43-250



4020

4021

4022

Sada zámečnických přílozých úhelníků
Try Squares Set
Zestaw kątowników ze stopką



CODE

S444-43-250



4020

4021

4022

Sady | Sady | Zestawy

Sada měřidel v kufru
 Measuring Tools Set in the box
 Zestaw narzędzi pomiarowych w kufrze



CODE
 SK46-27-250

6040-05-150
 4022

Sada měřidel
 Measuring Tools Set
 Zestaw narzędzi pomiarowych



CODE
 S46-27-250

6040-05-150
 4022

Sada měřidel v kufru
 Measuring Tools Set in the box
 Zestaw narzędzi pomiarowych w kufrze



CODE
 SK678-32-001

6000
 7002
 8001

Sada měřidel
 Measuring Tools Set
 Zestaw narzędzi pomiarowych



CODE
 S678-32-001

6000
 7002
 8001

Sada analogových mikrometrů 0-100mm v kufru
 Set of Analog Micrometers 0-100mm in the box
 Zestaw mikrometrów analogowych 0-100mm w kufrze



CODE
 SK777-42-100

7002
 7004
 7006
 7008

Sada analogových mikrometrů 0-100mm
 Set of Analog Micrometers 0-100mm
 Zestaw mikrometrów analogowych 0-100mm



CODE
 S777-42-100

7002
 7004
 7006
 7008

Sady | Sady | Zestawy

Sada digitálních mikrometrů 0-100mm v kufru
Set of Digital Micrometers 0-100mm in the box
Zestaw mikrometrów cyfrowych 0-100mm w kufrze



CODE

SK777-45-100



7031-02-025

7031-02-050

7031-02-075

7031-02-100

Sada digitálních mikrometrů 0-100mm
Set of Digital Micrometers 0-100mm
Zestaw mikrometrów cyfrowych 0-100mm



CODE

S777-45-100



7031-02-025

7031-02-050

7031-02-075

7031-02-100

Sada příložených DIN úhelníků - tř. př. 1
Set of try DIN squares - class I
Zestaw DIN kątowników - kl. 1



CODE

S444-13-150



4034-12-007

4034-12-010

4034-12-015

Sada plochých DIN úhelníků - tř. př. 1
Set of flat DIN squares - class I
Zestaw DIN kątowników - kl.1



CODE

S444-13-151



4033-12-007

4033-12-010

4033-12-015

Sada příložených přesných úhelníků
Precision Try Squares "Bu" Set
Zestaw kątowników precyzyjnych ze stopką typu "Bu"



ČSN II **ČSN 25 5103**

CODE

S444-23-250



4052

4053

4054

Sada měřidel v kufru
Measuring Tools Set in the box
Zestaw narzędzi pomiarowych w kufrze



CODE

SK6781-47-001



6040-02-150

7002

8001

1017-02-015

Sady | Sady | Zestawy

Sada mezních válečkových kalibrů
Set of Plug Gauges
Zestaw sprawdzianów do gwintów metrycznych



CODE	
92000-H7-012	
92003H7	3H7
92004H7	4H7
92005H7	5H7
92006H7	6H7
92008H7	8H7
92010H7	10H7
92012H7	12H7

Sada mezních závitových trnů
Set of Thread Plug Gauges
Zestaw sprawdzianów, szpilki gwintowane



CODE	
93000-6H-012	
93003-6H	M3
93004-6H	M4
93005-6H	M5
93006-6H	M6
93008-6H	M8
93010-6H	M10
93012-6H	M12



CODE	
	92000-H7-020
92003H7	3H7
92004H7	4H7
92005H7	5H7
92006H7	6H7
92008H7	8H7
92010H7	10H7
92012H7	12H7
92014H7	14H7
92016H7	16H7
92018H7	18H7
92020H7	20H7



CODE	
	93000-6H-020
93003-6H	M3
93004-6H	M4
93005-6H	M5
93006-6H	M6
93008-6H	M8
93010-6H	M10
93012-6H	M12
93014-6H	M14
93016-6H	M16
93018-6H	M18
93020-6H	M20

Sada mezních závitových kroužků
Set of Thread Ring Gauges
Zestaw mierników gwintowanych, pierścienie

Prezentační sada v kufru
Presentation set in a case
Zestaw prezentacyjny w etui



CODE		CODE	
94000-6g-12D		94000-6g-12Z	
94003-6gD	M3	94003-6gZ	M3
94004-6gD	M4	94004-6gZ	M4
94005-6gD	M5	94005-6gZ	M5
94006-6gD	M6	94006-6gZ	M6
94008-6gD	M8	94008-6gZ	M8
94010-6gD	M10	94010-6gZ	M10
94012-6gD	M12	94012-6gZ	M12



CODE
SK7171-01-006
6041-97-150
6040-05-150
1155-95-001
7033-95-025
7030-05-025
4026-28-006

Kalibry | Gauges | Sprawdziany

Nastavovací kroužek DIN2250C
Setting Ring DIN 2250 C
Sprawdzian pierścieniowy DIN2250C



CODE	
91002,5	D 2,5 mm
91003	D 3 mm
91003,5	D 3,5 mm
91004	D 4 mm
91004,5	D 4,5 mm
91005	D 5 mm
91006	D 6 mm
91007	D 7 mm
91008	D 8 mm
91009	D 9 mm
91010	D 10 mm
91011	D 11 mm
91012	D 12 mm
91013	D 13 mm
91014	D 14 mm
91015	D 15 mm
91016	D 16 mm
91017	D 17 mm
91018	D 18 mm
91020	D 20 mm
91022	D 22 mm
91024	D 24 mm
91025	D 25 mm
91030	D 30 mm
91032	D 32 mm
91033	D 33 mm
91034	D 34 mm
91035	D 35 mm
91038	D 38 mm

CODE	
91040	D 40 mm
91042	D 42 mm
91045	D 45 mm
91046	D 46 mm
91050	D 50 mm
91055	D 55 mm
91060	D 60 mm
91065	D 65 mm
91070	D 70 mm
91075	D 75 mm
91080	D 80 mm
91085	D 85 mm
91090	D 90 mm
91100	D 100 mm
91125	D 125 mm
91150	D 150 mm
91175	D 175 mm
91200	D 200 mm
91225	D 225 mm
91250	D 250 mm
91275	D 275 mm
91300	D 300 mm



Sortiment kalibrů v samostatném katalogu!
Range of Gauges in separate catalog!
Asortyment sprawdzianów w oddzielnym katalogu!
ONLINE: https://www.k-met.com/KATALOG_KALIBRY_CZSKPL.pdf

Kompletní sortiment kalibrů včetně cen a skladové dostupnosti naleznete na našem e-shopu!
Pełny asortyment kalibrów, w tym ceny i dostępność towaru, znajdziesz w naszym sklepie internetowym!
You can find the complete assortment of gauges, including prices and stock availability, on our e-shop!

Kalibry | Gauges | Sprawdziany

Mezní válečkový kalibr DIN 7162, DIN 7164

Plug Gauge DIN 7162, DIN 7164

Sprawdzian graniczny tłoczkowy DIN 7162, DIN 7164



Řada kalibrů H8 skladem
Gauges series H8 in stock
Sprawdziany serii H 8 w magazynie

CODE	
92002H7	D 2 H7
92002,5H7	D 2,5 H7
92003H7	D 3 H7
92004H7	D 4 H7
92005H7	D 5 H7
92006H7	D 6 H7
92007H7	D 7 H7
92008H7	D 8 H7
92009H7	D 9 H7
92010H7	D 10 H7
92011H7	D 11 H7
92012H7	D 12 H7
92013H7	D 13 H7
92014H7	D 14 H7
92015H7	D 15 H7
92016H7	D 16 H7
92017H7	D 17 H7
92018H7	D 18 H7
92019H7	D 19 H7
92020H7	D 20 H7
92021H7	D 21 H7
92022H7	D 22 H7
92023H7	D 23 H7
92024H7	D 24 H7
92025H7	D 25 H7
92026H7	D 26 H7
92028H7	D 28 H7
92029H7	D 29 H7
92030H7	D 30 H7
92031H7	D 31 H7

CODE	
92032H7	D 32 H7
92033H7	D 33 H7
92034H7	D 34 H7
92035H7	D 35 H7
92036H7	D 36 H7
92037H7	D 37 H7
92038H7	D 38 H7
92039H7	D 39 H7
92040H7	D 40 H7
92041H7	D 41 H7
92042H7	D 42 H7
92044H7	D 44 H7
92045H7	D 45 H7
92046H7	D 46 H7
92047H7	D 47 H7
92048H7	D 48 H7
92050H7	D 50 H7
92055H7	D 55 H7
92060H7	D 60 H7
92065H7	D 65 H7
92070H7	D 70 H7
92075H7	D 75 H7
92080H7 *	D 80 H7
92085H7 *	D 85 H7
92090H7 *	D 90 H7
92095H7 *	D 95 H7
92100H7 *	D 100 H7

* dobrá i zmetková strana se samostatnou rukojetí

* Go and NoGo side with separate handle

* przechodnia i nieprzechodnia część z oddzielnym uchwytem

Kompletní sortiment kalibrů včetně cen a skladové dostupnosti naleznete na našem e-shopu!
Pełny asortyment kalibrów, w tym ceny i dostępność towaru, znajdziesz w naszym sklepie internetowym!
You can find the complete assortment of gauges, including prices and stock availability, on our e-shop!

Kalibry | Gauges | Sprawdziany

Hloubkoměr pro závitý s noniem
Depth Gauge with vernier for threads
Głębokościomierz do gwintów (tylko uchwyt)

0,01



CODE		
93000-02-001	M3 - M6	0,1 mm
93000-02-002	M8 - M12	0,1 mm

Kalibr pro hloubkoměr
Thread gauge for depth gauge
Sprawdzian do gwintów do głębokościomierza

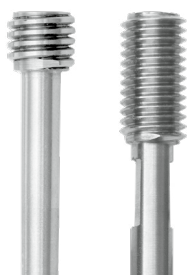

CODE	
93003-6H-02-001	M3
93004-6H-02-001	M4
93005-6H-02-001	M5
93006-6H-02-001	M6
93008-6H-02-002	M8
93010-6H-02-002	M10
93012-6H-02-002	M12

Na poptávku dodáme i jiné velikosti kalibrů s různým stoupáním.
On request, we also supply other sizes of gauges with different pitches.
Na życzenie dostarczamy również inne rozmiary sprawdzianów o różnym skoku gwintu.

Kalibry | Gauges | Sprawdziany

Mezní závitový trn - Metrický závit M, DIN 13
 Thread Plug Gauge - Metric Thread M, DIN 13
 Sprawdzian graniczny do gwintów metrycznych M, DIN 13

Mezní závitový trn - trubkový závit G, DIN EN ISO 228
 Thread Plug Gauge - Pipe Thread G, DIN EN ISO 228
 Sprawdzian graniczny do gwintów rurowych G, DIN EN ISO 228



CODE	
93001,6-6H	D M1,6-6H
93002-6H	D M2-6H
93002,5-6H	D M2,5-6H
93003-6H	D M3-6H
93003,5-6H	D M3,5-6H
93004-6H	D M4-6H
93005-6H	D M5-6H
93006-6H	D M6-6H
93008-6H	D M8-6H
93010-6H	D M10-6H
93012-6H	D M12-6H
93014-6H	D M14-6H
93016-6H	D M16-6H
93018-6H	D M18-6H
93020-6H	D M20-6H
93022-6H	D M22-6H
93024-6H	D M24-6H
93027-6H	D M27-6H
93030-6H	D M30-6H
93033-6H	D M33-6H
93036-6H	D M36-6H
93045-6H	D M45-6H
93048-6H	D M48-6H

CODE	
93301	G 1/16"
93302	G 1/8"
93303	G 1/4"
93304	G 3/8"
93305	G 1/2"
93306	G 5/8"
93307	G 3/4"
93308	G 7/8"
93309	G 1"
93310	G 1 1/8"
93311	G 1 1/4"
93312	G 1 1/2"
93313	G 1 3/4"
93314	G 2"
93315	G 2 1/4"
93316	G 2 1/2"
93317	G 2 3/4"
93318 *	G 3"

- * dobrá i zmetková strana se samostatnou rukojetí
- * Go and NoGo side with separate handle
- * przechodnia i nieprzechodnia część z oddzielnym uchwytem

Jemné stoupání závitových kalibrů skladem

Fine-pitch Gauges in stock

Sprawdziany o małym skoku gwintu posiadamy na magazynie

Kalibry | Gauges | Sprawdziany

Mezní závitový kroužek - dobrý, DIN 13
 Thread Ring Gauge - Metric Thread - Go, DIN 13
 Sprawdzian pierścieniowy do gwintów metrycznych - przechodni, DIN 13



CODE	
94003-6gD	D M3-6g
94003,5-6gD	D M3,5-6g
94004-6gD	D M4-6g
94005-6gD	D M5-6g
94006-6gD	D M6-6g
94008-6gD	D M8-6g
94010-6gD	D M10-6g
94012-6gD	D M12-6g
94014-6gD	D M14-6g
94016-6gD	D M16-6g
94018-6gD	D M18-6g
94020-6gD	D M20-6g
94022-6gD	D M22-6g
94024-6gD	D M24-6g
94030-6gD	D M30-6g
94033-6gD	D M33-6g
94036-6gD	D M36-6g

Mezní závitový kroužek - trubkový závit G, dobrý, DIN EN ISO 228
 Thread Ring Gauge - Pipe Thread G, Go, DIN EN ISO 228
 Sprawdzian do gwintów metrycznych G - przechodni, DIN EN ISO 228

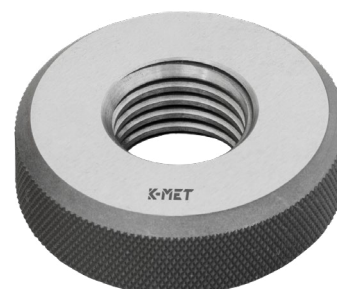

CODE	
94301D	G 1/16"
94302D	G 1/8"
94303D	G 1/4"
94304D	G 3/8"
94305D	G 1/2"
94306D	G 5/8"
94307D	G 3/4"
94308D	G 7/8"
94309D	G 1"
94310D	G 1 1/8"
94311D	G 1 1/4"
94312D	G 1 1/2"
94313D	G 1 3/4"
94314D	G 2"
94315D	G 2 1/4"
94316D	G 2 1/2"
94317D	G 2 3/4"
94318D	G 3"

Jemné stoupání kalibrů skladem
Fine Pitch Gauges in stock
Sprawdziany o małym skoku gwintu posiadamy na magazynie

Kalibry | Gauges | Sprawdziany

Mezní závitový kroužek - zmetkový, DIN 13
 Thread Ring Gauge - Metric Thread - NoGo, DIN 13
 Sprawdzian pierścieniowy do gwintów metrycznych - nieprzechodni, DIN 13

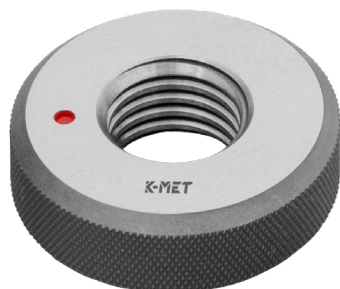

CODE	
94003-6gZ	D M3-6g
94003,5-6gZ	D M3,5-6g
94004-6gZ	D M4-6g
94005-6gZ	D M5-6g
94006-6gZ	D M6-6g
94008-6gZ	D M8-6g
94010-6gZ	D M10-6g
94012-6gZ	D M12-6g
94014-6gZ	D M14-6g
94016-6gZ	D M16-6g
94018-6gZ	D M18-6g
94020-6gZ	D M20-6g
94022-6gZ	D M22-6g
94024-6gZ	D M24-6g
94030-6gZ	D M30-6g
94033-6gZ	D M33-6g
94036-6gZ	D M36-6g

Mezní závitový kroužek - trubkový závit G, zmetkový, DIN EN ISO 228
 Thread Ring Gauge - Pipe Thread G, NoGo, DIN EN ISO 228
 Sprawdzian do gwintów metrycznych G - nieprzechodni, DIN EN ISO 228

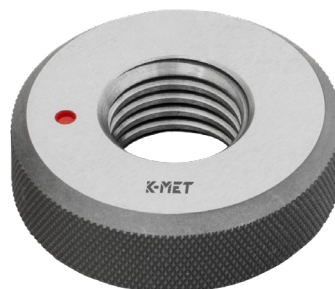

CODE	
94301Z	G 1/16"
94302Z	G 1/8"
94303Z	G 1/4"
94304Z	G 3/8"
94305Z	G 1/2"
94306Z	G 5/8"
94307Z	G 3/4"
94308Z	G 7/8"
94309Z	G 1"
94310Z	G 1 1/8"
94311Z	G 1 1/4"
94312Z	G 1 1/2"
94313Z	G 1 3/4"
94314Z	G 2"
94315Z	G 2 1/4"
94316Z	G 2 1/2"
94317Z	G 2 3/4"
94318Z	G 3"

Široký sortiment kalibrů skladem
 Wide range of Gauges in stock
 Różnego typu sprawdz. mamy na magazynie
BSW, UNC, UN(E)F, TR, Pg, Rp / R, NPT(F)

Sortiment kalibrů v samostatném katalogu!
 Range of Gauges in separate catalog!
 Asortyment sprawdzianów w oddzielnym katalogu!
 ONLINE: https://www.k-met.com/KATALOG_KALIBRY_CZSKPL.pdf



Kompletní sortiment kalibrů včetně cen a skladové dostupnosti naleznete na našem e-shopu!
 Pełny asortyment kalibrów, w tym ceny i dostępność towaru, znajdziesz w naszym sklepie internetowym!
 You can find the complete assortment of gauges, including prices and stock availability, on our e-shop!

Ostatní | Others | Inne

Infračervený teploměr bezkontaktní digitální
Non-contact digital infrared thermometer
Bezdotykový cyfrowy termometr na podczerwień



CODE		
8700-05-700	-50 °C ~ +700 °C	0,1 °C

Průmyslový endoskop
Industrial endoscope
Endoskop przemysłowy



CODE	
8600-05-150	1280x720



- » Okamžitě prohlížejte živé inspekční video na 4,5" IPS HD displeji.
- » Vysoké rozlišení 720p pro pořizování snímků a nahrávání videa.
- » Obrazový výklopný monitor o 180°.
- » Vysoká citlivost pro čip HD kamery ve špičce při slabém osvětlení.
- » LED přisvícení napomáhá práci v temných oblastech.
- » Dodáváno včetně kabelu 1m. Na zakázku dodáme kabel až do 15m.

- » View live inspection video instantly on the 4.5" IPS HD display.
- » 720p high definition for image capture and video recording.
- » 180° image flip monitor.
- » High sensitivity for low-light HD camera chip in the tip.
- » LED light assisting dark area work.
- » Supplied with a 1m cable. We can supply a cable up to 15m to order.

CODE		d
8600-00-003	3 m	8 mm
8600-00-005	5 m	8 mm

- » Natychmiastowe oglądanie wideo z inspekcji na żywo na 4,5" wyświetlaczu IPS HD.
- » Wysoka rozdzielczość 720p do robienia zdjęć i nagrywania filmów.
- » Monitor odchylany o 180°.
- » Wysoka czułość układu kamery HD w szczytowych warunkach słabego oświetlenia.
- » Podświetlenie LED ułatwia pracę w ciemnych obszarach.
- » W zestawie kabel o długości 1m. Na zamówienie możemy dostarczyć kabel o długości do 15m.

Digitalní momentový klíč
Digital torque wrench
Cyfrowy klucz dynamometryczny



CODE			
8200-05-020	1/4"	2 - 20 Nm	0,01
8200-05-100	3/8"	10 - 100 Nm	0,1
8200-05-300	1/2"	30 - 300 Nm	0,1
8200-05-400	3/4"	40 - 400 Nm	0,1

Doplňkový sortiment | Additional assortment | Dodatkowy asortyment

Úhelník dřevěný, stolařský
Wooden Square
Kątownik drewniany stolarski



CODE	↔
4065	300x150 mm
4066	400x200 mm
4067	500x250 mm

Kosořez dřevěný
Wooden Angle Holder
Drewniany szablon do skosów



CODE	↔	↔
9001	60°	280x90x60 mm

Úhloměr dřevěný
Bevel Protractor - Wooden Type
Kątomierz drewniany



CODE	↔	↔
9002	30°, 45°, 60° a 90°	250 mm

Rejsek
Wooden Marking Gauge
Rysik słupkowy traserski



CODE	↔
9003	250x100 mm

Pravítko cejchované 1m - pro prodejny a provozy s metráží
Certified ruler - Wooden Type
Przymiar drewniany cechowany - dla sklepów i do operacji z metrażem



CODE	↔	↔
1072	1 m	35x9 mm

Platnost cejchu od státní zkušebny je daný rok + dva následující.
The validity of the mark from the State Examination Office
is given year + two following.

Ważność miary po badaniach państwowych na rok + dwa następujące.

Měřítko dřevěné
Wooden Rule
Przymiar drewniany

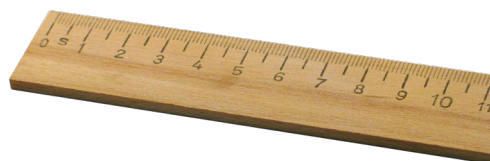

CODE	↔	↔
1070-02-030	300 mm	35x7 mm
1070-02-050	500 mm	35x7 mm
1070-02-100	1000 mm	37x6 mm

Doplňkový sortiment | Additional assortment | Dodatkowy asortyment

Měřicí teleskopická tyč
Telescopic Measuring Rod
Przymiar teleskopowy



CODE	
1054	3 m
1055	5 m
1056	8 m

Skládací dřevěný metr PROFI
Wooden Folding Ruler
Miara składana drewniana z obrzeżem metalowym PROFI



CODE		
8060	1 m	16 mm
8065	2 m	16 mm
8067	3 m	16 mm

Krejčovský metr samonavíjecí
Tailor Tape automatic
Metr krawiecki rozwijany



CODE	
8074	1,5 m

Skládací plastový metr
Plastic Folding Ruler
Miara składana z tworzywa



CODE		
8071	2 m	15 mm
8070	1 m	15 mm

Měřítka hliníková s úkosem
Aluminium Straight Edge
Przymiar aluminiowy ze skosem



CODE	
1007-1	400 mm
1008-1	600 mm
1009-1	1000 mm

Dálkoměr laserový PROFESSIONAL, NEW DESIGN
Digit. Laser Distance Meter PROFESSIONAL, NEW DESIGN
Dalmierz laserowy - PROFESSIONAL, NEW DESIGN



CODE		
9040-05-040	40 m	± 2 mm
9040-05-060	60 m	± 2 mm
9040-05-080	80 m	± 2 mm
9040-05-100	100 m	± 2 mm

Rejstřík | Index | Spis kodu produktů

1001-02-030	2	1025	5	1046-03-112	11	1133-02-020	16	1155-95-010	22	3022-05-060	23
1001-02-050	2	1026	5	1046-03-122	11	1134-0,01/D	16	1155-951-0005	22	3022-05-080	23
1001-02-100	2	1027-02-050	3	1046-13-038	11	1134-0,02/D	16	1155-952-0005	22	3022-05-100	23
1001-02-150	2	1027-02-100	3	1046-13-047	11	1134-0,03/D	16	1156-02-010	20	3025	27
1001-02-200	2	1027-07-050	3	1046-13-083	11	1134-0,04/D	16	1156-02-102	20	3025-2	27
1001-07-030	2	1027-07-100	3	1046-13-087	11	1134-0,05/D	16	1156-02-110	20	3025-5	27
1001-07-050	2	1033-12-050	7	1046-13-103	11	1134-0,06/D	16	1156-02-222	20	3026	27
1001-07-100	2	1033-12-075	7	1046-13-112	11	1134-0,07/D	16	1156-05-001	22	3026-30	27
1001-07-150	2	1033-22-100	7	1046-13-122	11	1134-0,08/D	16	1160	19	3034	10
1001-07-200	2	1033-22-150	7	1047-13-003	11	1134-0,09/D	16	1160-02-117	19	3035	10
1007-02-030	2	1033-22-200	7	1047-13-005	11	1134-0,10/D	16	1162-05-050	54	3036	10
1007-02-050	2	1038-02-050	7	1047-13-010	11	1134-0,12/D	16	1162-05-080	54	3037	10
1007-02-100	2	1038-02-100	7	1047-13-015	11	1134-0,15/D	16	1162-05-100	54	3039-02-130	28
1007-02-150	2	1038-02-150	7	1047-13-020	11	1134-0,18/D	16	1162-08-050	54	3039-02-188	28
1007-02-200	2	1039-02-050	6	1047-14-001	11	1134-0,20/D	16	1162-08-080	54	3039-02-280	28
1007-07-030	2	1039-02-075	6	1047-14-002	11	1134-0,25/D	16	1162-08-100	54	3039-02-375	28
1007-07-050	2	1039-02-100	6	1047-14-003	11	1134-0,30/D	16	1163-1	54	3039-02-500	28
1007-07-100	2	1039-02-150	6	1047-14-004	11	1134-0,35/D	16	2001	26	3039-02-750	28
1007-07-150	2	1039-02-200	6	1047-14-005	11	1134-0,40/D	16	2001-05-020	26	3040-02-045	28
1007-07-200	2	1039-02-250	6	1047-14-006	11	1134-0,45/D	16	2001-05-040	26	3042-02-900	28
1007-1	85	1039-12-050	6	1047-14-007	11	1134-0,50/D	16	2001-05-060	26	3044-02-160	28
1008-1	85	1039-12-075	6	1047-14-008	11	1134-0,55/D	16	2002	26	3045-02-630	28
1009-1	85	1039-12-100	6	1047-14-009	11	1134-0,60/D	16	2002-1	26	3046-02-180	28
1012-02-030	3	1039-12-150	6	1047-14-010	11	1134-0,65/D	16	2003	26	3047-02-710	28
1012-02-050	3	1039-12-200	6	1050-13-032	11	1134-0,70/D	16	2006	26	3048-02-315	28
1012-02-100	3	1039-12-250	6	1050-13-047	11	1134-0,75/D	16	2009	26	3049-06-315	28
1012-02-150	3	1039-17-050	6	1050-13-087	11	1134-0,80/D	16	2010	26	3049-06-355	28
1012-02-200	3	1039-17-075	6	1050-13-103	11	1134-0,85/D	16	2012	26	3049-06-400	28
1012-02-250	3	1039-17-100	6	1054	85	1134-0,90/D	16	2012-05-025	26	3049-06-500	28
1012-02-300	3	1039-17-150	6	1055	85	1134-0,95/D	16	2012-05-040	26	3049-06-560	28
1012-02-400	3	1039-17-200	6	1056	85	1134-1,00/D	16	2012-05-060	26	3049-06-620	28
1012-02-500	3	1039-17-250	6	1061-05-075	7	1138-02-015	17	2013	26	3049-06-630	28
1012-04-030	3	1039-22-050	6	1061-05-100	7	1138-02-030	17	2014	26	3049-06-710	28
1012-04-050	3	1039-22-075	6	1061-05-125	7	1138-02-045	17	2016	26	3049-06-900	28
1012-04-100	3	1039-22-100	6	1061-05-150	7	1138-02-060	17	2017	26	3049-08-100	28
1012-07-024	3	1039-22-150	6	1061-05-200	7	1138-12-006	17	2018	26	3049-08-110	28
1012-07-030	3	1039-22-200	6	1061-05-300	7	1138-12-015	17	2019	26	3049-08-120	28
1012-07-040	3	1039-22-250	6	1061-05-400	7	1140	17	2034-02-150	24	3049-08-130	28
1012-07-050	3	1039-22-300	6	1061-05-500	7	1141	17	2034-02-200	24	3049-08-145	28
1012-07-100	3	1041-02-030	8	1061-07-075	7	1142	17	2034-02-300	24	3049-08-160	28
1012-07-150	3	1041-02-040	8	1061-07-125	7	1146	17	2034-02-500	24	3049-08-180	28
1012-07-200	3	1041-02-063	8	1070-02-030	84	1147	17	2040-02-150	24	3049-08-200	28
1017	5	1041-02-100	8	1070-02-050	84	1148	17	2040-02-200	24	3049-08-210	28
1017-02-015	5	1041-02-120	8	1070-02-100	84	1148-02-014	17	2040-02-250	24	3049-08-220	28
1017-02-030	5	1041-02-160	8	1072	84	1148-02-016	17	2040-02-300	24	3049-08-240	28
1017-02-050	5	1041-02-210	8	1089-02-120	13	1148-02-020	17	2040-02-500	24	3049-08-270	28
1017-02-100	5	1041-02-216	8	1089-02-200	13	1148-02-022	17	2050-05-1000	24	3049-08-300	28
1017-02-150	5	1041-12-040	8	1089-02-250	13	1148-02-030	17	2050-05-150	24	3049-08-340	28
1017-02-200	5	1041-12-063	8	1089-07-120	13	1150	18	2050-05-200	24	3049-08-380	28
1017-05-015	5	1041-12-100	8	1089-07-200	13	1150-04-250	19	2050-05-300	24	3049-08-430	28
1017-05-030	5	1041-12-120	8	1089-07-250	13	1150-05-250	19	2050-05-500	24	3049-08-490	28
1017-05-050	5	1041-12-160	8	1089-07-315	13	1150-07-150	19	2050-05-600	24	3049-08-550	28
1017-05-100	5	1041-12-210	8	1092-02-268	13	1150-1	18	2050-05-800	24	3049-08-620	28
1018	5	1041-80	9	1093	13	1150-5	18	2050-25-150	24	3049-08-800	28
1019	5	1041-82	9	1093-20	13	1150-6	18	2050-25-200	24	3052	28
1020	5	1041-84	9	1094-04-008	12	1150-61	18	2050-25-300	24	3053	28
1021	5	1041-86	9	1094-04-010	12	1150-7	18	2051-05-150	25	3054	28
1022	5	1041-88	9	1094-1	12	1151	18	2051-05-200	25	3055	28
1022-0	5	1041-90	9	1094-14-015	12	1151-1	18	2051-05-300	25	3056	28
1022-02-030	5	1042-02-030	8	1094-2	12	1151-61	18	2051-05-500	25	3057	28
1022-02-050	5	1042-02-040	8	1094-3	12	1152	19	2052-05-150	24	3058	28
1022-02-100	5	1042-02-060	8	1119-10	14	1152	19	2070-02-150	25	3059	28
1022-1	5	1042-02-080	8	1120-02-010	14	1153	19	2070-02-200	25	3059-1	28
1023	5	1042-02-100	8	1120-02-012	14	1153	19	2070-02-250	25	3060	28
1023-02-015	4	1042-02-120	8	1120-02-013	14	1155-00-100	23	2070-02-300	25	4001	36
1023-02-030	4	1042-12-030	8	1120-02-014	14	1155-02-001	20	2074	25	4001-03-063	36
1023-02-030P	4	1042-12-040	8	1120-02-015	15	1155-02-005	20	2074-1	25	4001-03-075	36
1023-02-050	4	1042-12-060	8	1120-05-011	15	1155-02-010	20	2075	25	4001-03-100	36
1023-02-050P	4	1042-12-080	8	1120-07-020	15	1155-02-025	20	2075-1	25	4001-03-150	36
1023-02-100	4	1042-12-100	8	1121	15	1155-02-030	20	2078	25	4001-03-200	36
1023-02-100P	4	1042-12-120	8	1122	15	1155-02-110	20	2078-1	25	4001-03-250	36
1023-05-015	4	1043-01-110	10	1123	15	1155-02-410	20	2078-2	25	4002	36
1023-05-030	4	1043-01-140	10	1124	15	1155-02-710	20	2078-3	25	4003	36
1023-05-030P	4	1043-01-200	10	1125	17	1155-05-001	21	3001	25	4004	36
1023-05-050	4	1043-02-100	10	1126	15	1155-05-010	21	3002	25	4006-02-120	37
1023-05-050P	4	1043-02-140	10	1127	15	1155-20-050	19	3014-02-020	23	4006-02-160	37
1023-05-100	4	1043-02-180	10	1128-02-007	17	1155-23-030	19	3014-02-030	23	4006-02-200	37
1023-05-100P	4	1043-03-070	10	1129-1	16	1155-25-001	21	3014-02-050	23	4007-02-120	37
1023-05-150	4	1043-03-130	10	1130	16	1155-25-010	21	3014-02-100	23	4007-02-160	37
1023-05-200	4	1043-03-200	10	1131	16	1155-25-705	22	3020-02-030	23	4007-02-200	37
1023-25-015	4	1046-03-038	11	1131-02-032	16	1155-28-050	19	3020-02-050	23	4010	34
1023-25-030	4	1046-03-047	11	1131-07-020	16	1155-35-001	21	3020-02-060	23	4011	34
1023-25-050	4	1046-03-083	11	1132	16	1155-35-010	21	3022-05-020	23	4012	34
1023-25-100	4	1046-03-087	11	1132-02-013	16	1155-7	23	3022-05-030	23	4013	34
1024	5	1046-03-103	11	1133	16	1155-95-0005	22	3022-05-050	23	4014	34

Rejstřík | Index | Spis kodu produktů

4015	34	4033-12-100	29	4049	33	6000	42	6040-05-200	48	6044-55-200	51
4016	34	4033-17-007	31	4051	33	6000-02-150	42	6040-05-300	48	6044-65-150	51
4020	34	4033-17-010	31	4052	33	6000-02-200	42	6040-1	54	6050	54
4020-30	36	4033-17-015	31	4053	33	6000-02-300	42	6040-14-150	49	6050-02-150	54
4020-31	36	4033-17-020	31	4054	33	6000-1	42	6040-14-200	49	7002	55
4020-32	36	4033-17-025	31	4054-122-250	35	6000-12-150	42	6040-14-300	49	7002-00-025	56
4020-33	36	4033-17-030	31	4055	33	6000-2	42	6040-15-150	50	7002-00-050	56
4020-34	36	4033-17-040	31	4056	33	6000-20	42	6040-15-200	50	7002-00-075	56
4020-35	36	4033-17-050	31	4058	34	6000-21	42	6040-15-300	50	7002-00-100	56
4020-36	36	4033-22-007	29	4059	34	6000-25	42	6040-2	49	7002-02-025	56
4020-37	36	4033-22-010	29	4060	34	6000-26	42	6040-25-500	48	7002-12-100	55
4020-38	36	4033-22-015	29	4061	34	6000-3	42	6040-35-150	53	7002-12-200	55
4021	34	4033-22-020	29	4061-1	34	6000-4	42	6040-35-200	53	7002-12-300	55
4022	34	4033-22-025	29	4062	37	6000-7	42	6040-35-300	53	7004	55
4023	34	4033-22-030	29	4062-1	37	6002	43	6040-35-400	53	7006	55
4024	34	4033-22-040	29	4062-2	37	6002-90-1	43	6040-35-500	53	7008	55
4025	34	4033-22-050	29	4062-3	37	6003	43	6040-35-600	53	7011	55
4025-1	34	4033-22-060	29	4062-4	37	6003-90-1	43	6040-45-150	53	7013	55
4026-02-006	32	4033-22-075	29	4062-5	37	6004-02-043	43	6040-45-200	53	7015	55
4026-02-007	32	4033-22-100	29	4063-10	37	6004-02-045	43	6040-45-300	53	7017	55
4026-02-010	32	4033-22-150	29	4063-11	37	6005-10	44	6040-45-400	53	7019	55
4026-02-015	32	4033-22-200	29	4063-12	37	6005-15	44	6040-45-500	53	7021	55
4026-02-020	32	4033-22-250	29	4063-13	37	6005-20	44	6040-45-600	53	7023	55
4026-02-025	32	4034	33	4063-14	37	6005-25	44	6040-55-150	52	7025	55
4026-02-030	32	4034-02-007	30	4065	84	6005-50	44	6040-55-151	52	7026	55
4026-02-040	32	4034-02-010	30	4066	84	6005-55	44	6040-55-200	52	7027	55
4026-02-050	32	4034-02-015	30	4067	84	6006-2	44	6040-55-300	52	7027-1	55
4026-12-006	32	4034-02-020	30	4080	37	6006-2	53	6040-65-150	52	7027-2	55
4026-12-007	32	4034-02-025	30	4085	37	6007-02-160	44	6040-65-200	52	7027-3	55
4026-12-010	32	4034-02-030	30	5017-02-050	38	6007-02-250	44	6040-65-300	52	7027-4	55
4026-12-015	32	4034-02-040	30	5017-02-600	38	6007-02-300	44	6040-75-200	50	7027-5	55
4026-12-020	32	4034-02-050	30	5017-05-150	38	6007-02-400	44	6040-75-210	50	7028-02-025	56
4026-12-025	32	4034-02-060	30	5017-97-150	38	6007-02-500	44	6040-85-150	53	7028-02-050	56
4026-12-030	32	4034-02-075	30	5018-0	38	6007-07-015	44	6040-85-200	53	7028-02-075	56
4026-12-040	32	4034-02-100	30	5018-1	38	6007-07-020	44	6040-85-300	53	7028-02-100	56
4026-12-050	32	4034-07-007	31	5018-2	38	6007-07-030	44	6041-15-025	52	7028-31	56
4026-12-060	32	4034-07-010	31	5018-3	38	6013-02-150	43	6041-15-050	52	7028-32	56
4026-12-153	32	4034-07-015	31	5018-4	38	6013-02-200	43	6041-2	49	7028-33	56
4026-12-154	32	4034-07-020	31	5018-5	38	6013-02-300	43	6041-25-150	49	7028-34	56
4026-12-250	32	4034-07-025	31	5018-6	38	6015-02-100	45	6041-35-060	52	7028-35	56
4026-28-006	32	4034-07-030	31	5022-01-025	41	6015-02-125	45	6041-35-100	52	7028-36	56
4027-03-060	29	4034-07-040	31	5022-02-030	41	6015-02-150	45	6041-45-200	53	7028-37	56
4027-03-080	29	4034-07-050	31	5022-03-020	41	6015-02-200	45	6041-55-150	53	7028-38	56
4027-03-100	29	4034-12-007	30	5022-03-035	41	6015-08-040	46	6041-75-200	53	7028-41	56
4027-03-150	29	4034-12-010	30	5022-03-060	41	6015-08-050	46	6041-97-150	47	7028-42	56
4028	36	4034-12-015	30	5022-03-075	41	6015-08-060	46	6041-97-200	47	7028-43	56
4028-1	36	4034-12-020	30	5022-04-035	41	6015-08-100	46	6041-97-300	47	7028-44	56
4029	36	4034-12-025	30	5022-04-080	41	6015-08-150	46	6042-2	49	7028-45	56
4029-1	36	4034-12-030	30	5022-1	41	6015-08-200	46	6042-20	50	7028-46	56
4030	36	4034-12-040	30	5035-3	38	6015-12-100	45	6043-05-100	51	7030-05-025	58
4030-1	36	4034-12-050	30	5035-4	38	6015-12-125	45	6043-05-125	51	7030-05-050	58
4031	35	4034-12-060	30	5036	38	6015-12-150	45	6043-05-150	51	7030-05-075	58
4031-03-020	35	4034-12-075	30	5036-02-008	38	6015-12-200	45	6043-05-200	51	7030-05-100	58
4031-03-025	35	4034-12-100	30	5036-08-006	38	6015-12-300	45	6043-15-100	51	7031-02-025	58
4031-03-030	35	4034-17-007	31	5036-5	38	6015-22-150	45	6043-15-125	51	7031-02-050	58
4032	35	4034-17-010	31	5050-02-150	39	6015-22-200	45	6043-15-150	51	7031-02-075	58
4033-02-007	29	4034-17-015	31	5050-02-200	39	6015-22-300	45	6043-15-200	51	7031-02-100	58
4033-02-010	29	4034-17-020	31	5050-02-250	39	6015-32-125	45	6043-15-300	51	7031-02-125	58
4033-02-015	29	4034-17-025	31	5050-02-300	39	6015-32-150	45	6043-25-125	51	7031-02-150	58
4033-02-020	29	4034-17-030	31	5050-02-400	39	6015-32-200	45	6043-25-150	51	7031-02-175	58
4033-02-025	29	4034-17-040	31	5050-02-500	39	6015-42-150	45	6043-35-125	51	7031-02-200	58
4033-02-030	29	4034-17-050	31	5051-02-150	39	6015-42-200	45	6043-35-150	51	7032-02-100	57
4033-02-040	29	4034-22-007	30	5051-02-200	39	6015-52-200	45	6043-415-150	50	7032-02-1000	57
4033-02-050	29	4034-22-010	30	5051-02-250	39	6015-52-300	45	6043-435-150	50	7032-02-200	57
4033-02-060	29	4034-22-015	30	5051-02-300	39	6015-62-100	45	6043-45-150	51	7032-02-300	57
4033-02-075	29	4034-22-020	30	5080-02-100	40	6015-72-200	45	6043-45-200	51	7032-02-400	57
4033-02-100	29	4034-22-025	30	5080-02-150	40	6015-72-300	45	6043-45-300	51	7032-02-500	57
4033-07-007	31	4034-22-030	30	5080-02-200	40	6022-02-150	46	6043-55-150	51	7032-02-600	57
4033-07-010	31	4034-22-040	30	5080-02-250	40	6022-12-150	46	6043-65-100	51	7032-02-700	57
4033-07-015	31	4034-22-050	30	5080-02-300	40	6022-22-150	46	6043-75-200	51	7032-02-800	57
4033-07-020	31	4034-22-060	30	5090-02-150	40	6022-32-150	46	6043-75-300	51	7032-02-900	57
4033-07-025	31	4034-22-075	30	5090-02-200	40	6022-42-200	46	6044-05-100	51	7033-95-025	57
4033-07-030	31	4034-22-100	30	5090-02-250	40	6022-52-150	46	6044-05-125	51	7033-95-050	57
4033-07-040	31	4034-22-150	30	5090-02-300	40	6022-52-200	46	6044-05-150	51	7033-95-075	57
4033-07-050	31	4034-22-200	30	5091-02-150	40	6022-62-100	46	6044-05-200	51	7033-95-100	57
4033-12-007	29	4034-22-250	30	5091-02-200	40	6040-00-075	54	6044-15-100	51	7040-05-010	59
4033-12-010	29	4035	33	5091-02-250	40	6040-00-155	54	6044-15-125	51	7040-1	59
4033-12-015	29	4036	33	5091-02-300	40	6040-01	54	6044-15-150	51	7040-15-010	59
4033-12-020	29	4037	33	5110-02-100	39	6040-02-150	49	6044-15-200	51	7041	59
4033-12-025	29	4038	33	5110-02-150	39	6040-02-200	49	6044-25-125	51	7041-02-025	59
4033-12-030	29	4039	33	5115-02-150	39	6040-02-300	49	6044-25-150	51	7041-02-050	59
4033-12-040	29	4045	33	5115-02-200	39	6040-05	54	6044-35-125	51	7043	60
4033-12-050	29	4046	33	5115-02-250	39	6040-05-100	48	6044-35-150	51	7051	60
4033-12-060	29	4047	33	5115-02-300	39	6040-05-150	48	6044-45-150	51	7052	60
4033-12-075	29	4048	33	5115-02-400	39	6040-05-151	48	6044-55-150	51	7053	60

Rejstřík | Index | Spis kodu produktů

7054	60	7090-02-250	64	8004-2-1	70	91003,5	77	92036H7	78	94006-6gD	81
7055	60	7090-02-275	64	8005	70	91004	77	92037H7	78	94006-6gZ	82
7056	60	7090-02-300	64	8010	71	91004,5	77	92038H7	78	94008-6gD	81
7057	60	7090-03-003	64	8011	71	91005	77	92039H7	78	94008-6gZ	82
7058	60	7090-03-006	64	8012	71	91006	77	92040H7	78	94010-6gD	81
7070-02-025	60	7090-03-012	64	8013	71	91007	77	92041H7	78	94010-6gZ	82
7070-02-050	60	7090-03-020	64	8014	71	91008	77	92042H7	78	94012-6gD	81
7070-02-075	60	7090-03-050	64	8017	71	91009	77	92044H7	78	94012-6gZ	82
7070-02-100	60	7090-03-100	64	8017-02-030	71	91010	77	92045H7	78	94014-6gD	81
7070-02-125	60	7095	61	8017-02-050	71	91011	77	92046H7	78	94014-6gZ	82
7070-02-150	60	7096	61	8018	71	91012	77	92047H7	78	94016-6gD	81
7070-02-175	60	7097	61	8019	71	91013	77	92048H7	78	94016-6gZ	82
7070-02-200	60	7098	61	8020	71	91014	77	92050H7	78	94018-6gD	81
7075-02-025	60	7098-1	61	8021	71	91015	77	92055H7	78	94018-6gZ	82
7075-02-050	60	7098-2	61	8039-3	68	91016	77	92060H7	78	94020-6gD	81
7075-02-075	60	7098-3	61	8039-5	68	91017	77	92065H7	78	94020-6gZ	82
7075-02-100	60	7098-4	61	8040	70	91018	77	92070H7	78	94022-6gD	81
7075-02-125	60	7098-5	61	8040-1	68	91020	77	92075H7	78	94022-6gZ	82
7075-02-150	60	7098-6	61	8040-2	68	91022	77	92080H7	78	94024-6gD	81
7075-02-175	60	7098-7	61	8040-3	68	91024	77	92085H7	78	94024-6gZ	82
7075-05-025	61	7098-8	61	8040-4	68	91025	77	92090H7	78	94030-6gD	81
7075-05-050	61	7100-02-030	62	8041	70	91030	77	92095H7	78	94030-6gZ	82
7075-05-075	61	7100-02-050	62	8041-2	69	91032	77	92100H7	78	94033-6gD	81
7075-05-100	61	7100-02-075	62	8042	70	91033	77	93000-02-001	79	94033-6gZ	82
7075-05-125	61	7100-02-100	62	8042-1	70	91034	77	93000-02-002	79	94036-6gD	81
7075-05-150	61	7103	62	8042-2	69	91035	77	93000-6H-012	76	94036-6gZ	82
7075-05-175	61	7103-02-025	62	8042-5	69	91038	77	93000-6H-020	76	94301D	81
7076-02-025	60	7110-0	65	8043	70	91040	77	93001,6-6H	80	94301Z	82
7076-05-025	61	7110-1	65	8043-2	69	91042	77	93002-6H	80	94302D	81
7077-05-025	61	7110-2	65	8044-10	69	91045	77	93002,5-6H	80	94302Z	82
7089-02-002	63	7110-3	65	8044-11	69	91046	77	93003-6H	80	94303D	81
7089-02-003	63	7110-5	65	8044-12	69	91050	77	93003-6H-02-001	79	94303Z	82
7089-02-004	63	7110-6	65	8044-13	69	91055	77	93003,5-6H	80	94304D	81
7089-02-005	63	7110-7	65	8044-14	69	91060	77	93004-6H	80	94304Z	82
7089-02-006	63	7110-80	65	8044-15	70	91065	77	93004-6H-02-001	79	94305D	81
7089-02-008	63	7110-81	65	8044-16	70	91070	77	93005-6H	80	94305Z	82
7089-02-010	63	7110-82	65	8044-17	70	91075	77	93005-6H-02-001	79	94306D	81
7089-02-012	63	7110-83	65	8044-20	69	91080	77	93006-6H	80	94306Z	82
7089-02-016	63	7110-85	65	8044-21	69	91085	77	93006-6H-02-001	79	94307D	81
7089-02-020	63	7110-86	65	8044-22	69	91090	77	93008-6H	80	94307Z	82
7089-02-025	63	7110-87	65	8045	72	91100	77	93008-6H-02-002	79	94308D	81
7089-02-030	63	7110-90	65	8046	72	91125	77	93010-6H	80	94308Z	82
7089-02-040	63	7110-91	65	8047	72	91150	77	93010-6H-02-002	79	94309D	81
7089-02-050	63	7110-92	65	8048	72	91175	77	93012-6H	80	94309Z	82
7089-02-063	63	7110-93	65	8050	72	91200	77	93012-6H-02-002	79	94310D	81
7089-02-075	63	7110-94	65	8051	72	91225	77	93014-6H	80	94310Z	82
7089-02-088	63	7110-95	65	8052	72	91250	77	93016-6H	80	94311D	81
7089-02-100	63	7110-96	65	8053	72	91275	77	93018-6H	80	94311Z	82
7089-02-125	63	7120	62	8054	71	91300	77	93020-6H	80	94312D	81
7089-02-150	63	7125	65	8054-0	71	92000-H7-012	76	93022-6H	80	94312Z	82
7089-02-175	63	7125-00-100	65	8054-1	71	92000-H7-020	76	93024-6H	80	94313D	81
7089-02-200	63	7125-00-200	65	8055	72	92002,5H7	78	93027-6H	80	94313Z	82
7089-02-225	63	7125-12	65	8055-1	72	92002H7	78	93030-6H	80	94314D	81
7089-02-250	63	7125-3	65	8055-2	72	92003H7	78	93033-6H	80	94314Z	82
7089-02-275	63	7126	66	8057-02-300	72	92004H7	78	93036-6H	80	94315D	81
7089-02-300	63	7126-02-025	66	8057-05-320	72	92005H7	78	93045-6H	80	94315Z	82
7089-03-003	63	7126-02-050	66	8057-15-320	72	92006H7	78	93048-6H	80	94316D	81
7089-03-006	63	7126-02-075	66	8060	85	92007H7	78	93301	80	94316Z	82
7089-03-012	63	7126-02-100	66	8065	85	92008H7	78	93302	80	94317D	81
7089-03-020	63	7126-1	66	8067	85	92009H7	78	93303	80	94317Z	82
7089-03-040	63	7126-2	66	8070	85	92010H7	78	93304	80	94318D	81
7089-03-100	63	7126-3	66	8071	85	92011H7	78	93305	80	94318Z	82
7090-02-002	64	7126-95-025	66	8074	85	92012H7	78	93306	80	S111-32-058	73
7090-02-003	64	7126-95-050	66	8200-05-020	83	92013H7	78	93307	80	S441-32-160	73
7090-02-004	64	7126-95-075	66	8200-05-100	83	92014H7	78	93308	80	S444-13-150	75
7090-02-005	64	7126-95-100	66	8200-05-300	83	92015H7	78	93309	80	S444-13-151	75
7090-02-006	64	7900-05-125	12	8200-05-400	83	92016H7	78	93310	80	S444-23-250	75
7090-02-008	64	7900-05-150	12	8600-00-003	83	92017H7	78	93311	80	S444-43-250	73
7090-02-010	64	8001	67	8600-00-005	83	92018H7	78	93312	80	S46-27-250	74
7090-02-012	64	8001-02-003	67	8600-05-150	83	92019H7	78	93313	80	S678-32-001	74
7090-02-016	64	8001-02-005	67	8700-05-700	83	92020H7	78	93314	80	S777-42-100	74
7090-02-020	64	8001-02-008	67	9001	84	92021H7	78	93315	80	S777-45-100	75
7090-02-025	64	8001-05-005	68	9002	84	92022H7	78	93316	80	SK111-32-058	73
7090-02-030	64			9003	84	92023H7	78	93317	80	SK441-32-160	73
7090-02-040	64	8001-2	70	9030	27	92024H7	78	93318	80	SK444-43-250	73
7090-02-050	64	8002	67	9031	27	92025H7	78	94000-6g-12D	76	SK46-27-250	74
7090-02-063	64	8002-02-003	67	9033	27	92026H7	78	94000-6g-12Z	76	SK678-32-001	74
7090-02-075	64	8002-02-005	67	9035	27	92028H7	78	94003-6gD	81	SK6781-47-001	76
7090-02-088	64	8002-02-008	67	9038	27	92029H7	78	94003-6gZ	82	SK7171-01-006	75
7090-02-100	64	8002-02-010	67	9040-05-040	85	92030H7	78	94003,5-6gD	81	SK777-42-100	74
7090-02-125	64	8002-10	72	9040-05-060	85	92031H7	78	94003,5-6gZ	82	SK777-45-100	75
7090-02-150	64	8002-2	70	9040-05-080	85	92032H7	78	94004-6gD	81		
7090-02-175	64	8003	67	9040-05-100	85	92033H7	78	94004-6gZ	82		
7090-02-200	64	8003-2	70	91002,5	77	92034H7	78	94005-6gD	81		
7090-02-225	64	8004-2	70	91003	77	92035H7	78	94005-6gZ	82		